

1

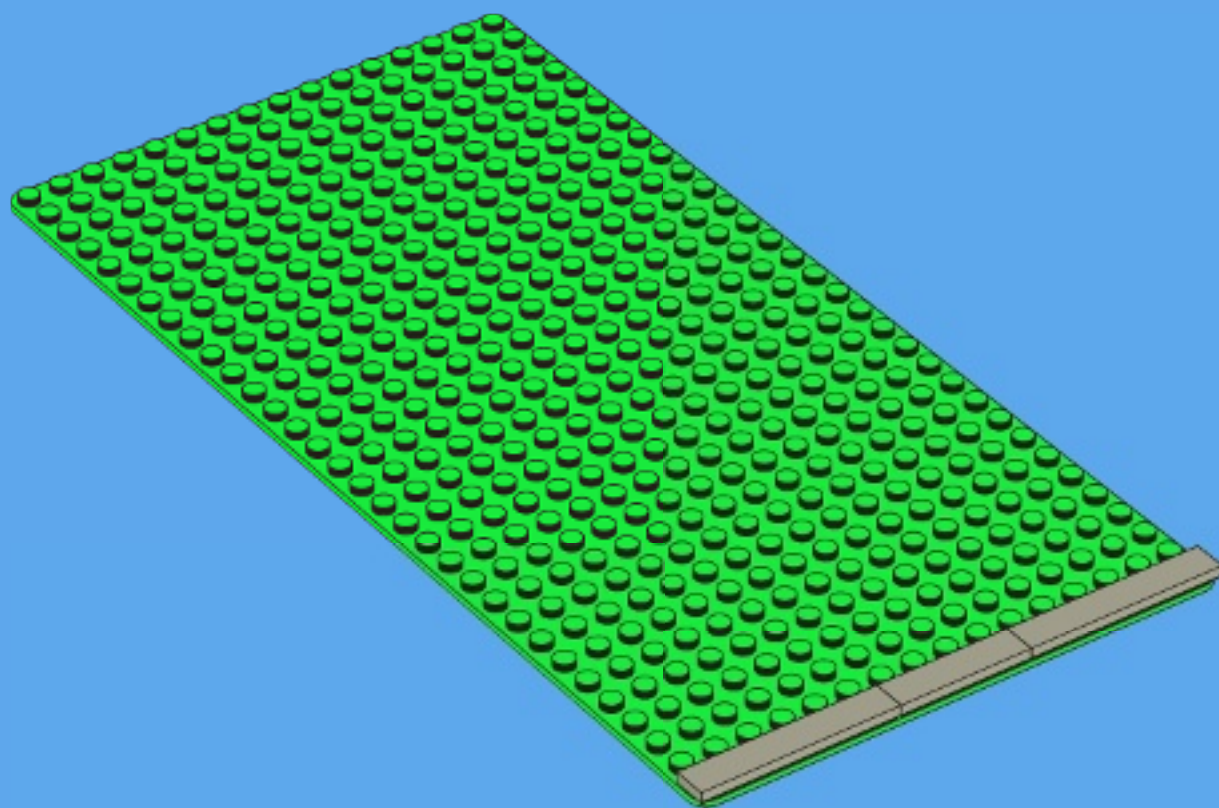

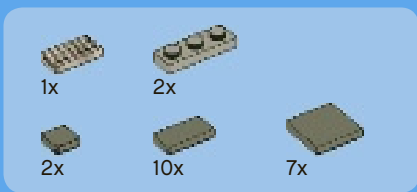

2

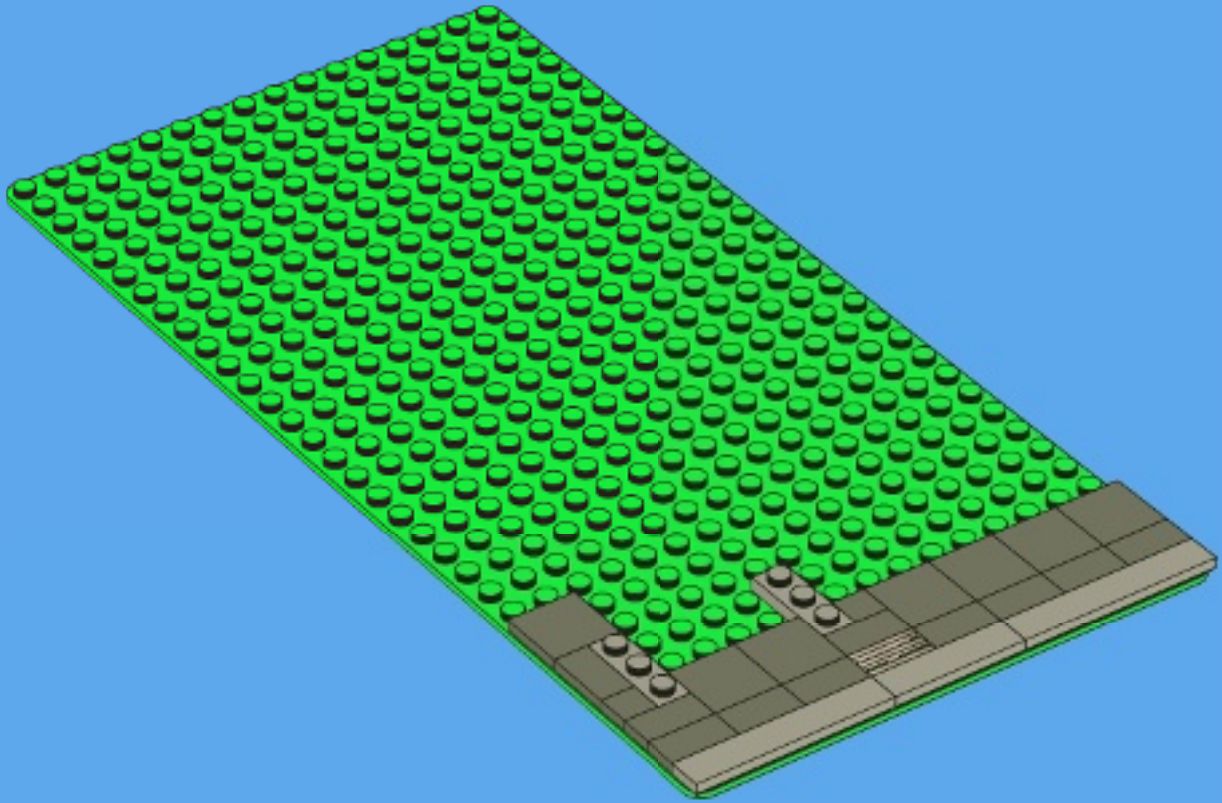

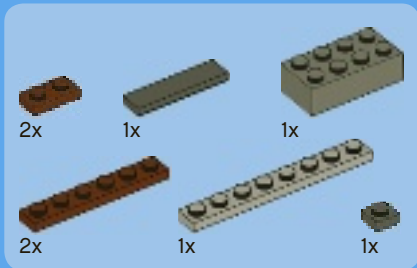

3

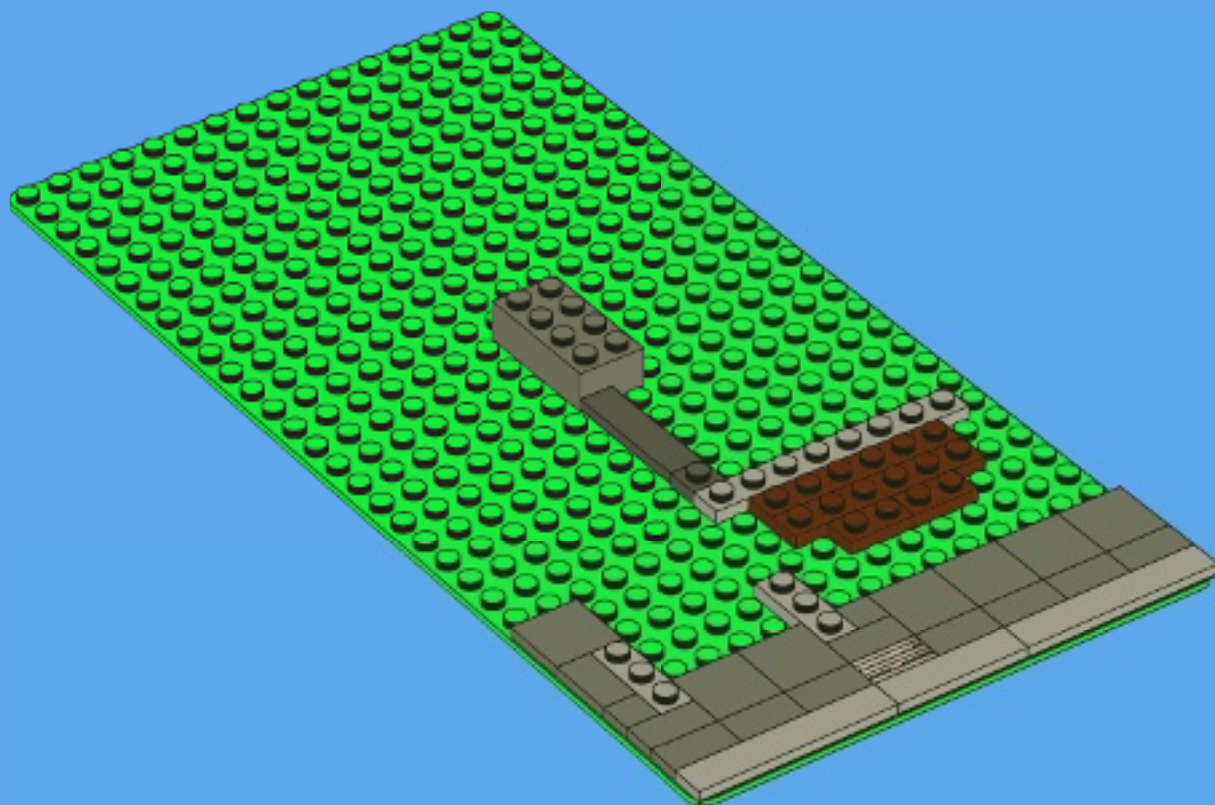

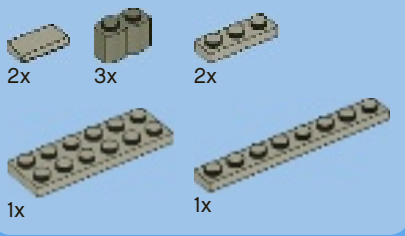

4

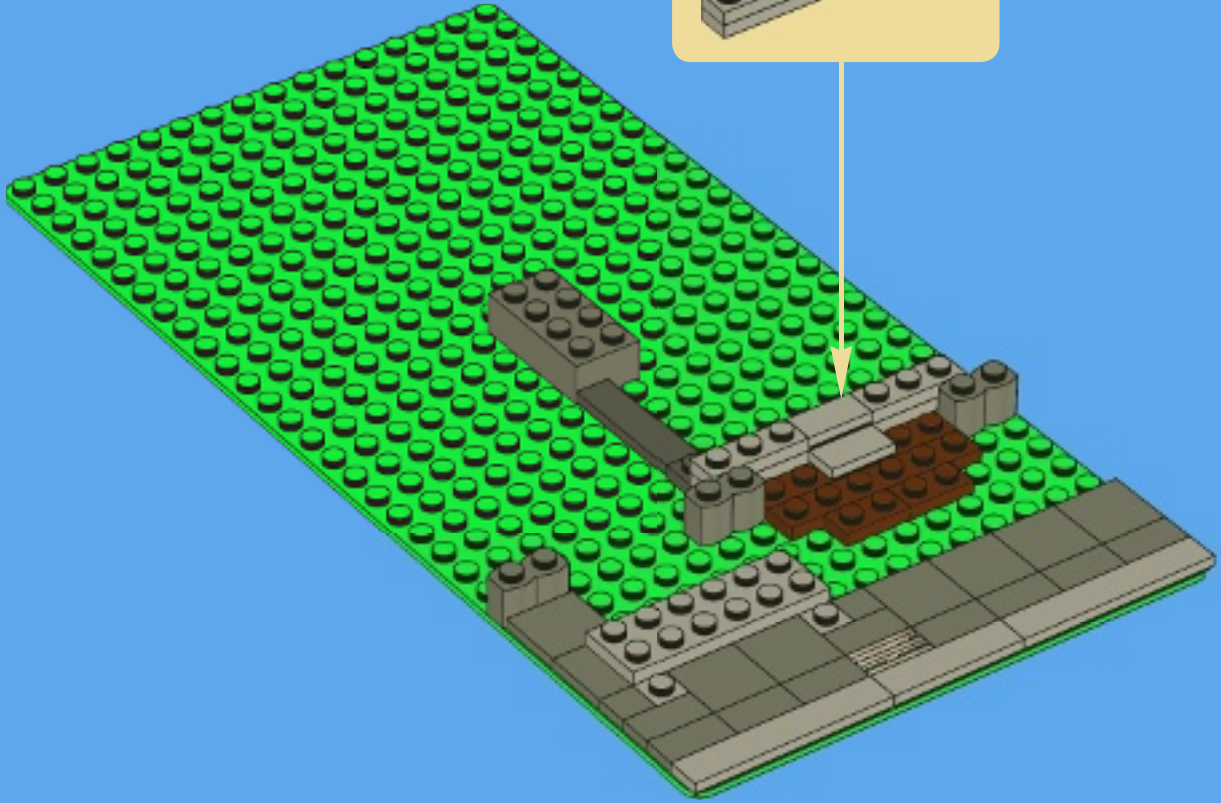
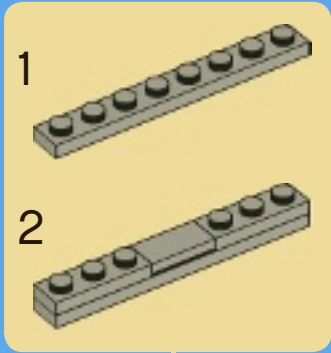

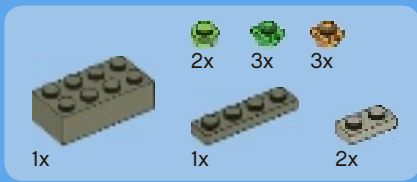

5

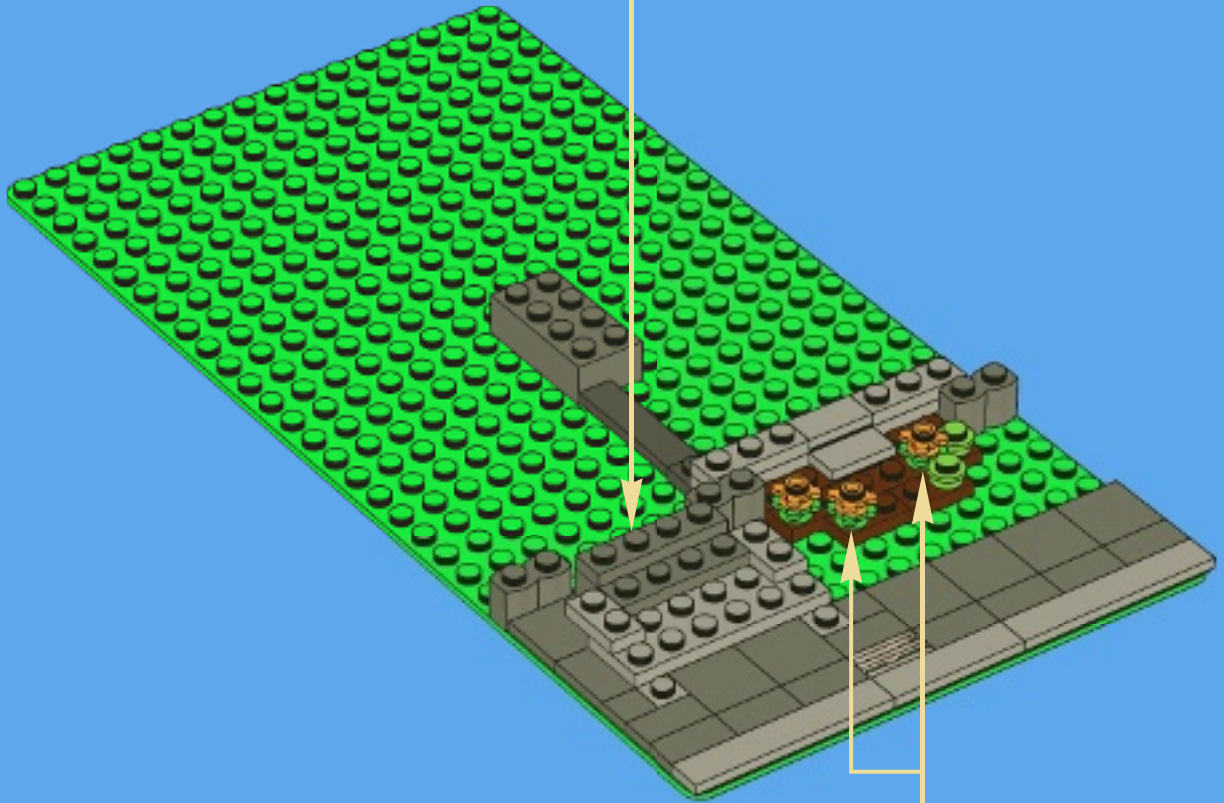
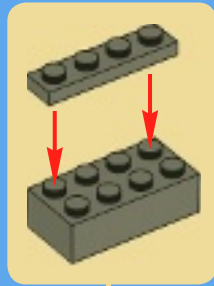

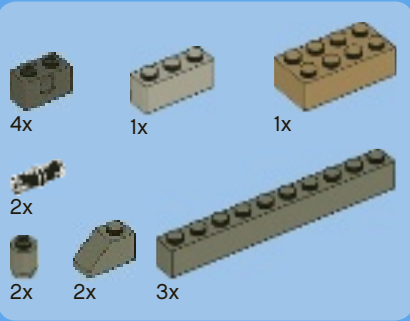

6

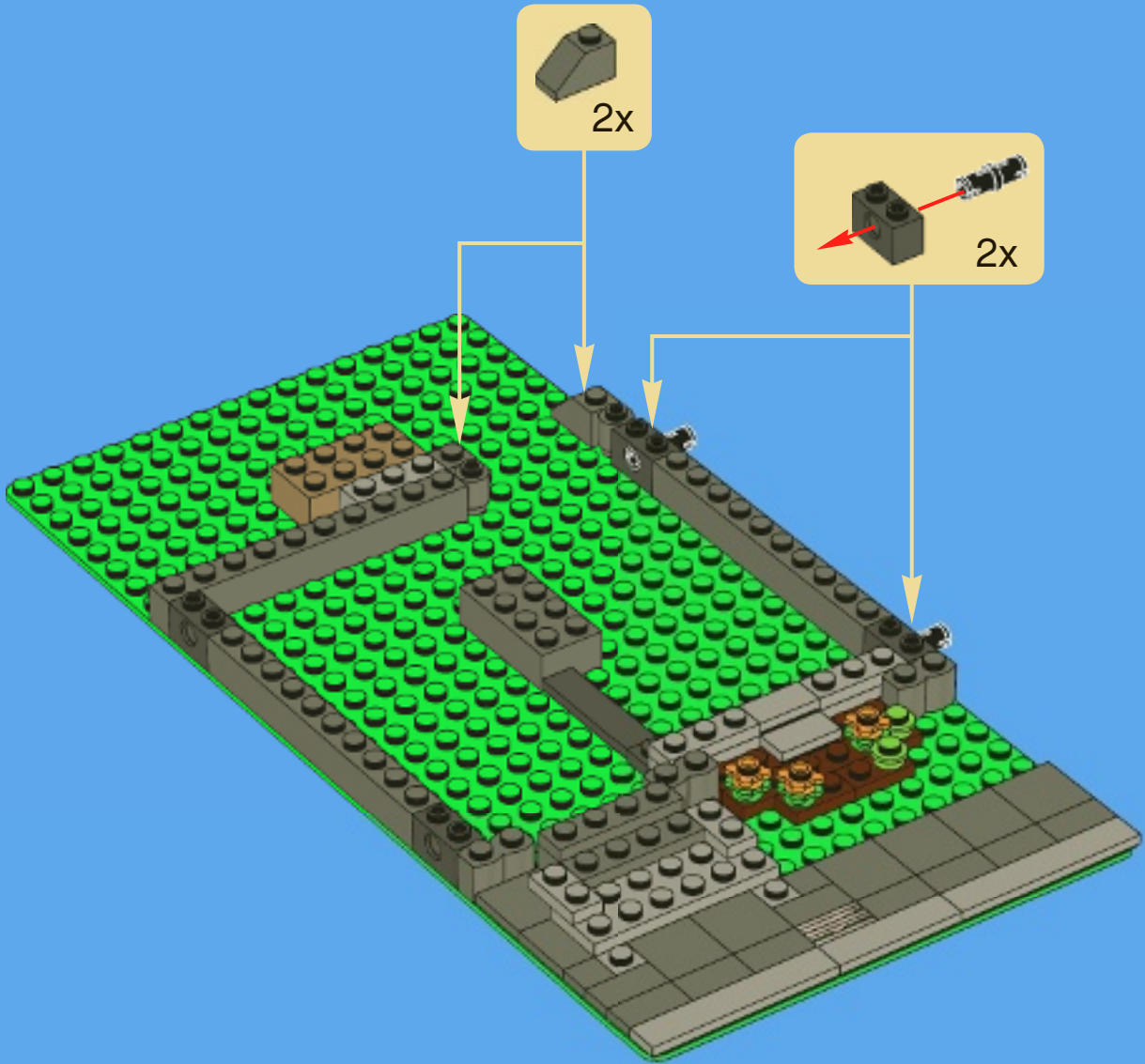



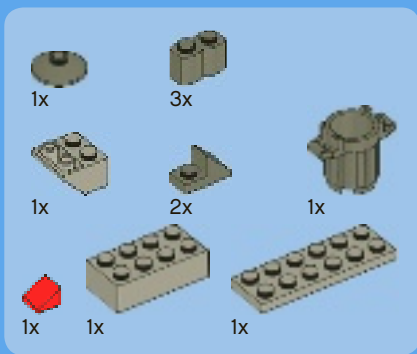

7

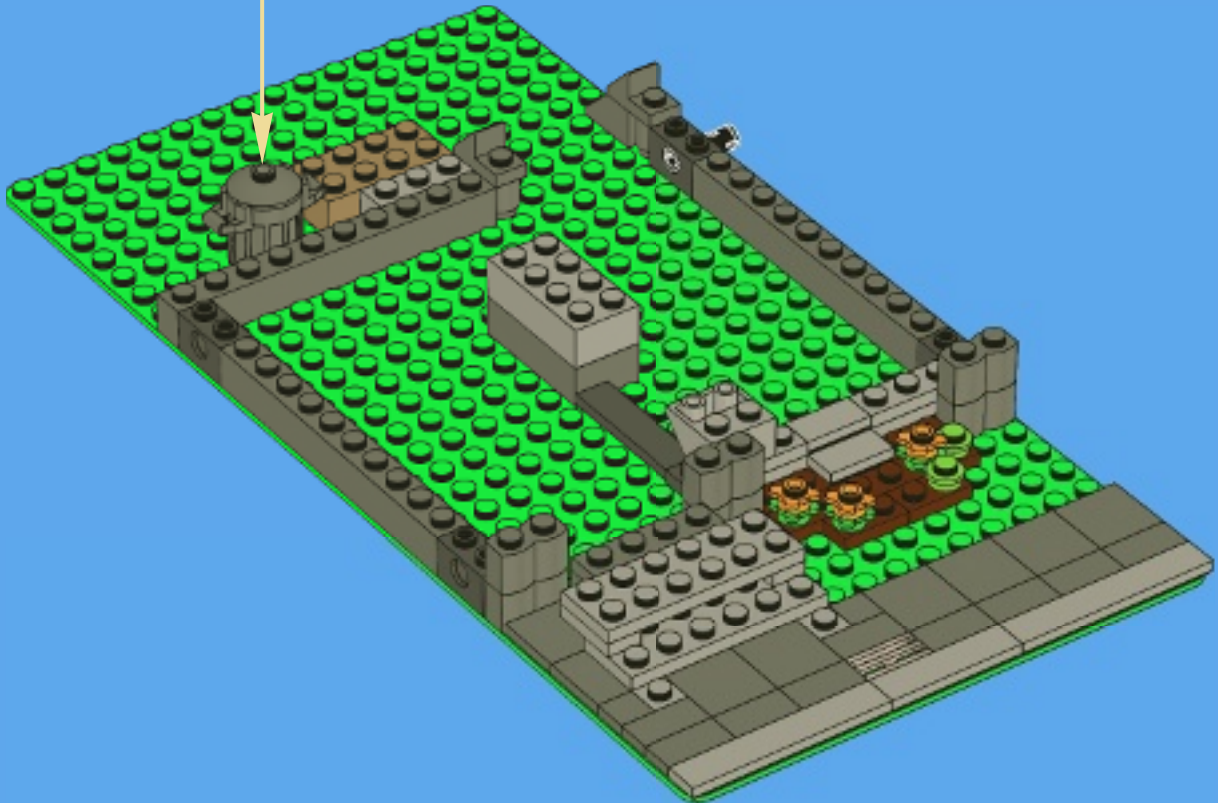
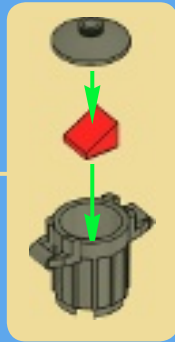

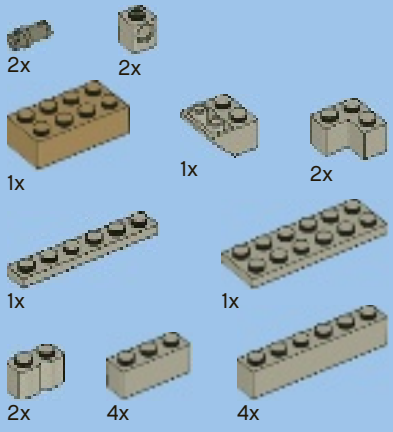

8

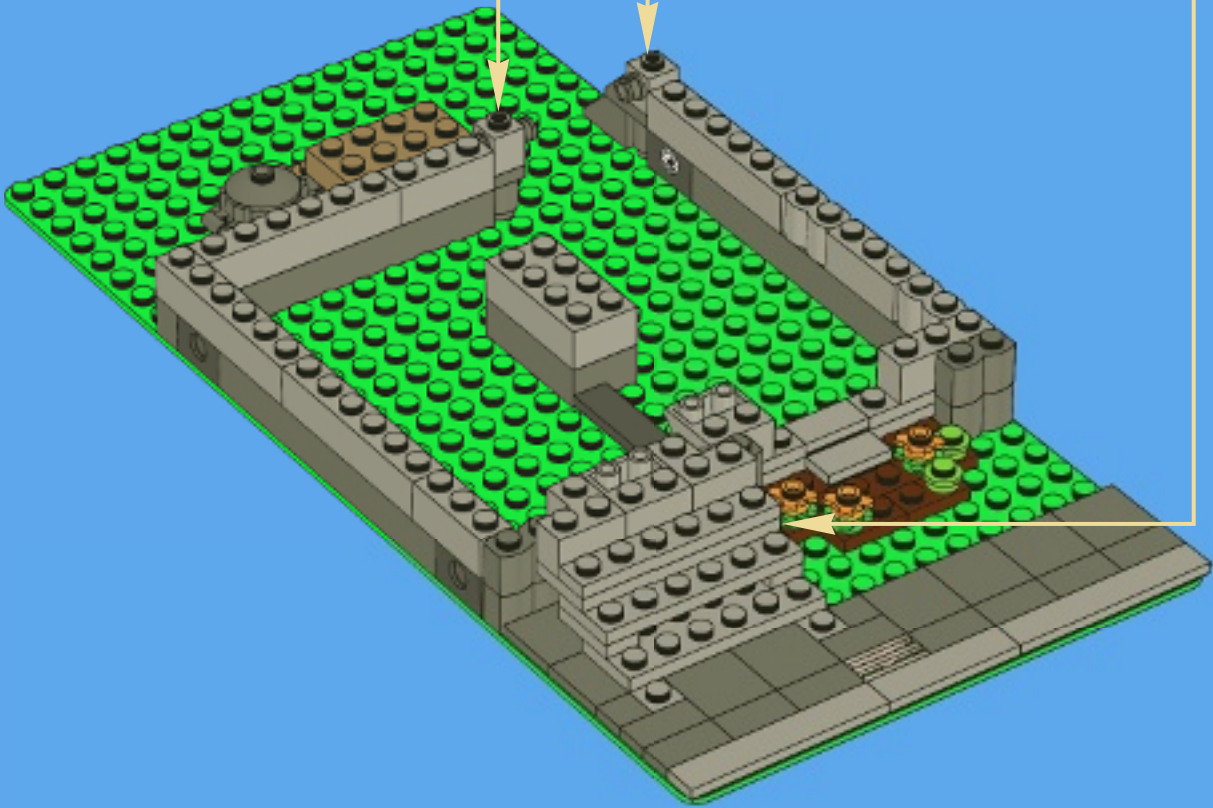
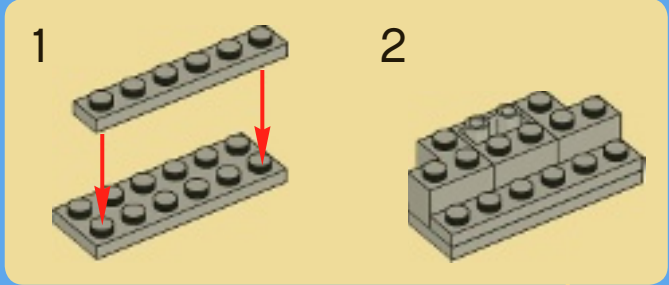
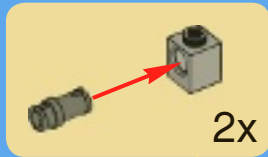

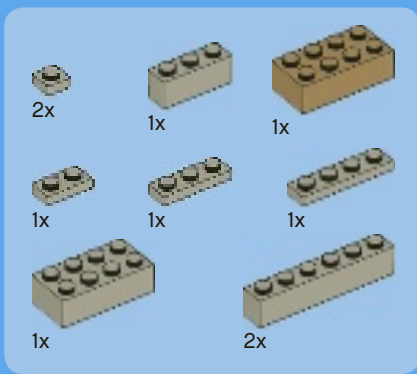

9

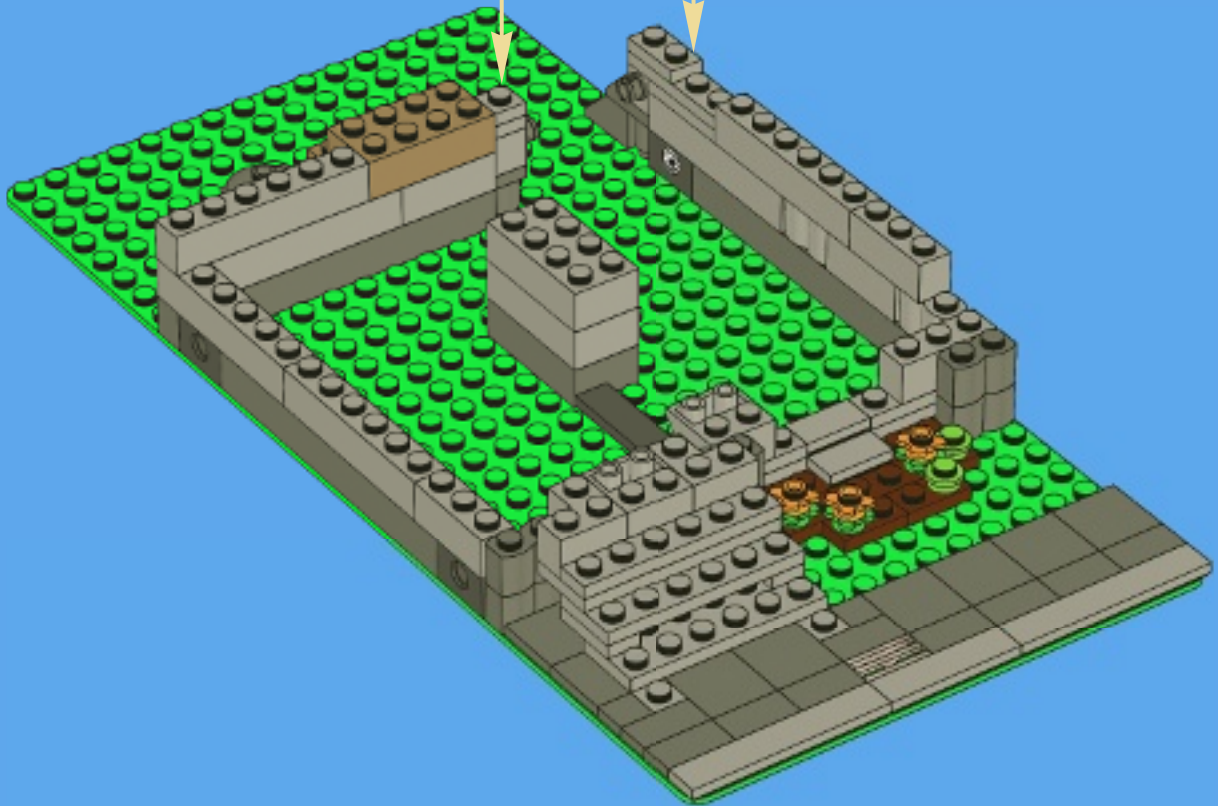
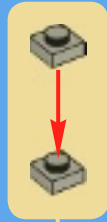
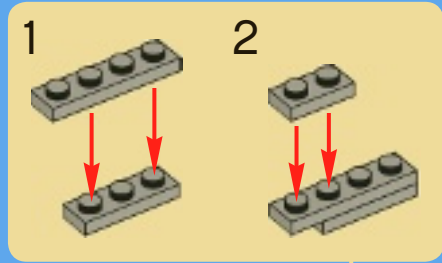

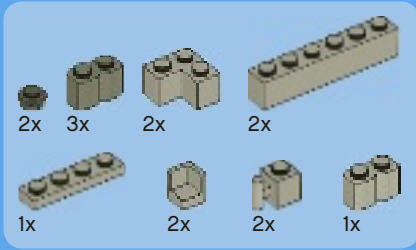

# 10

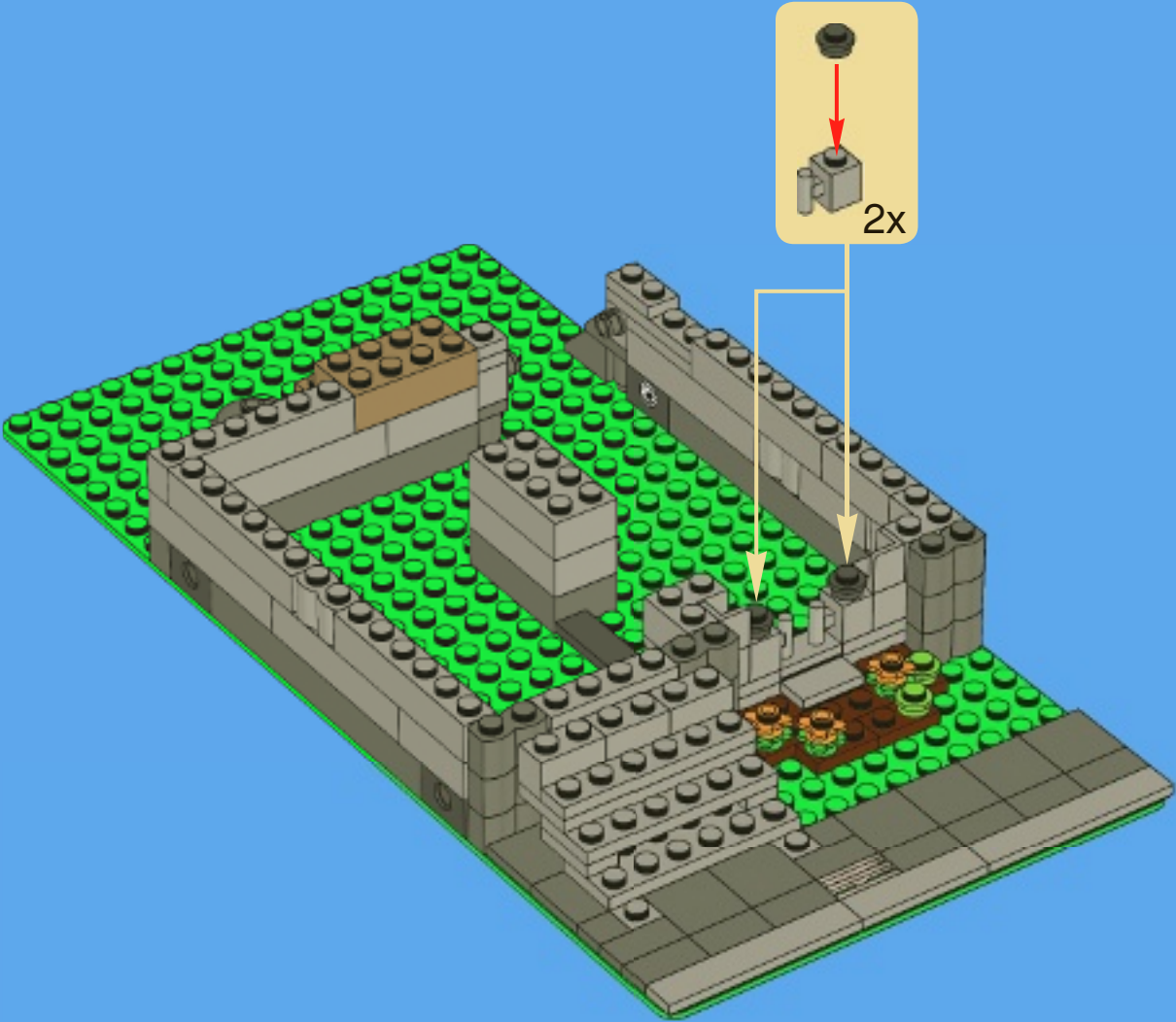

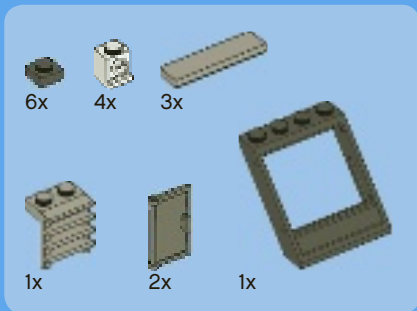

11

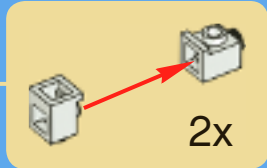
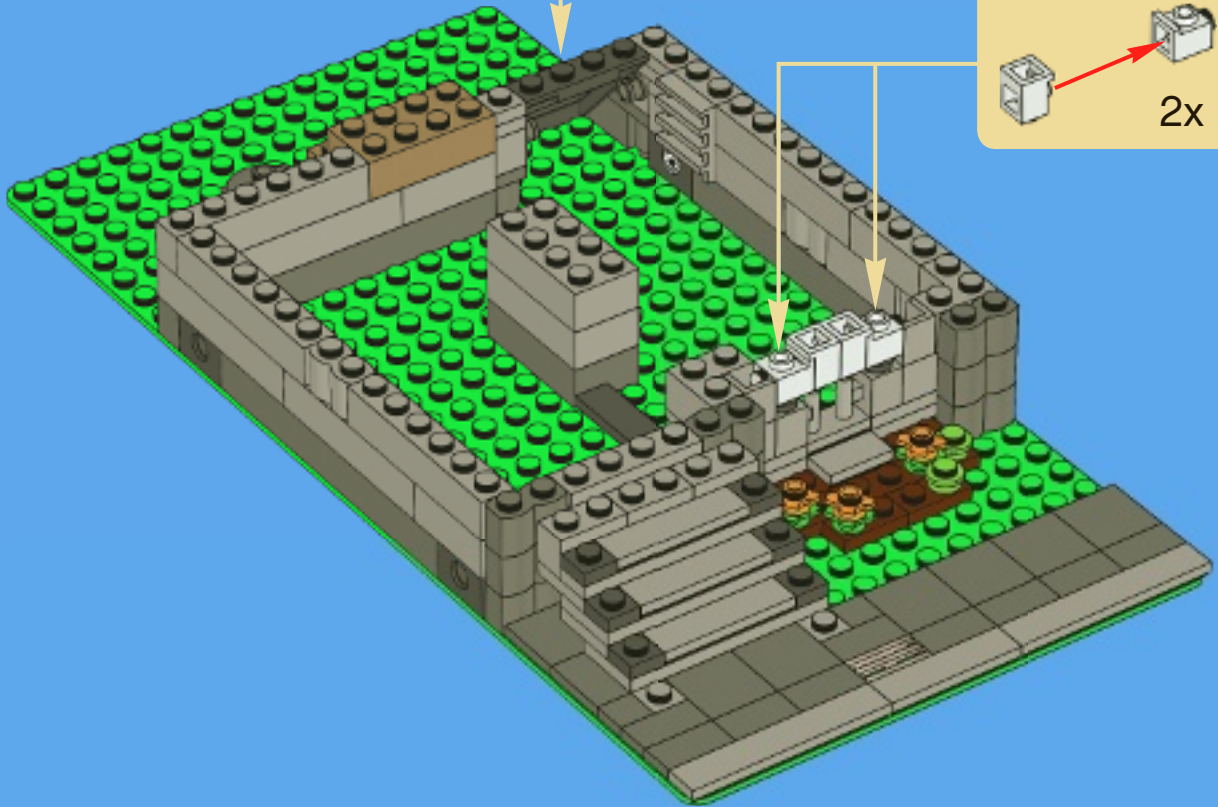
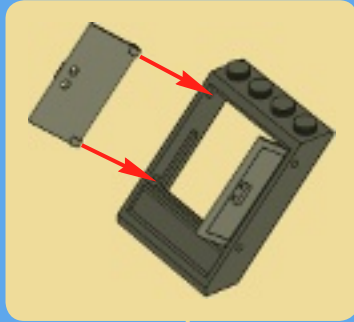

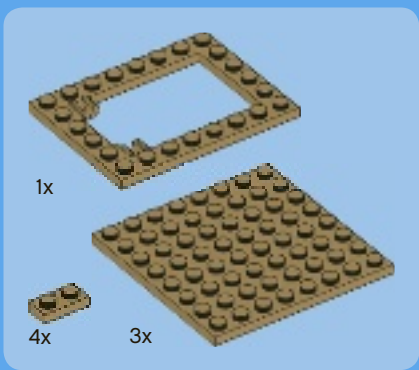

12

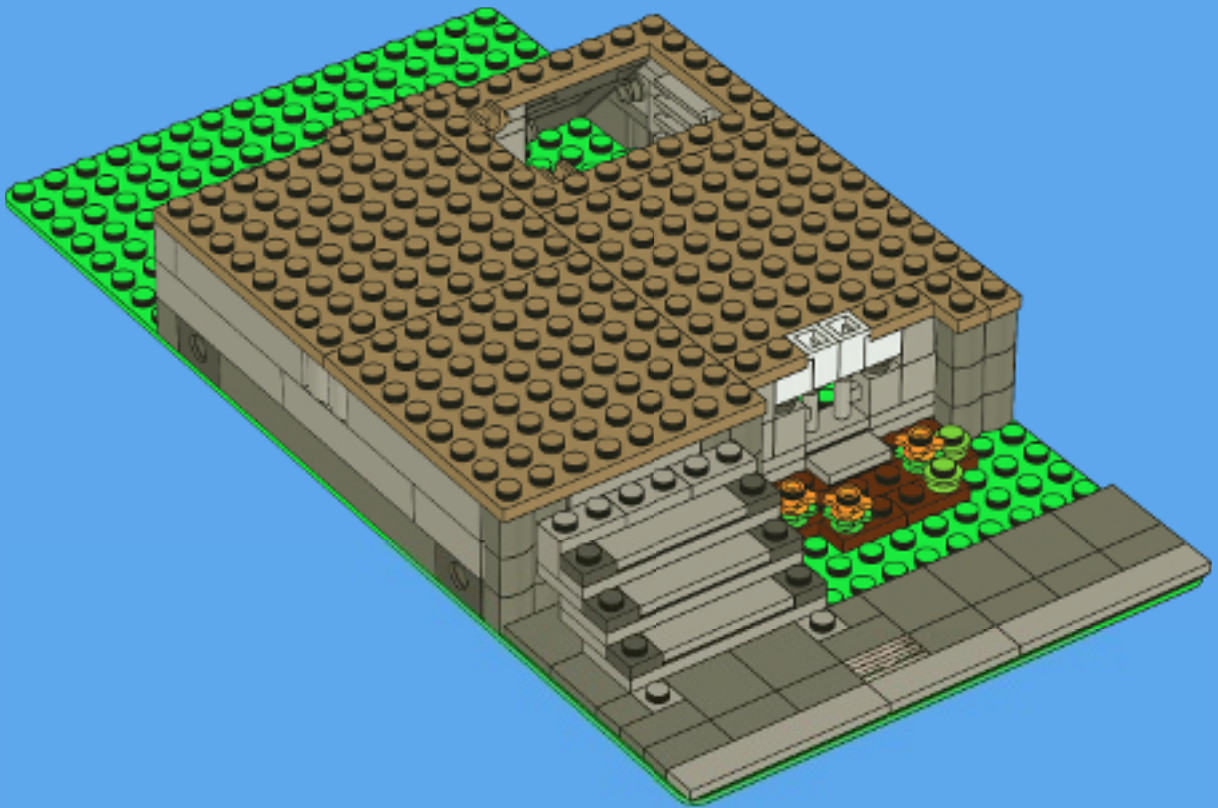

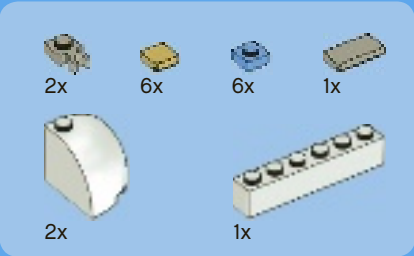

# 13

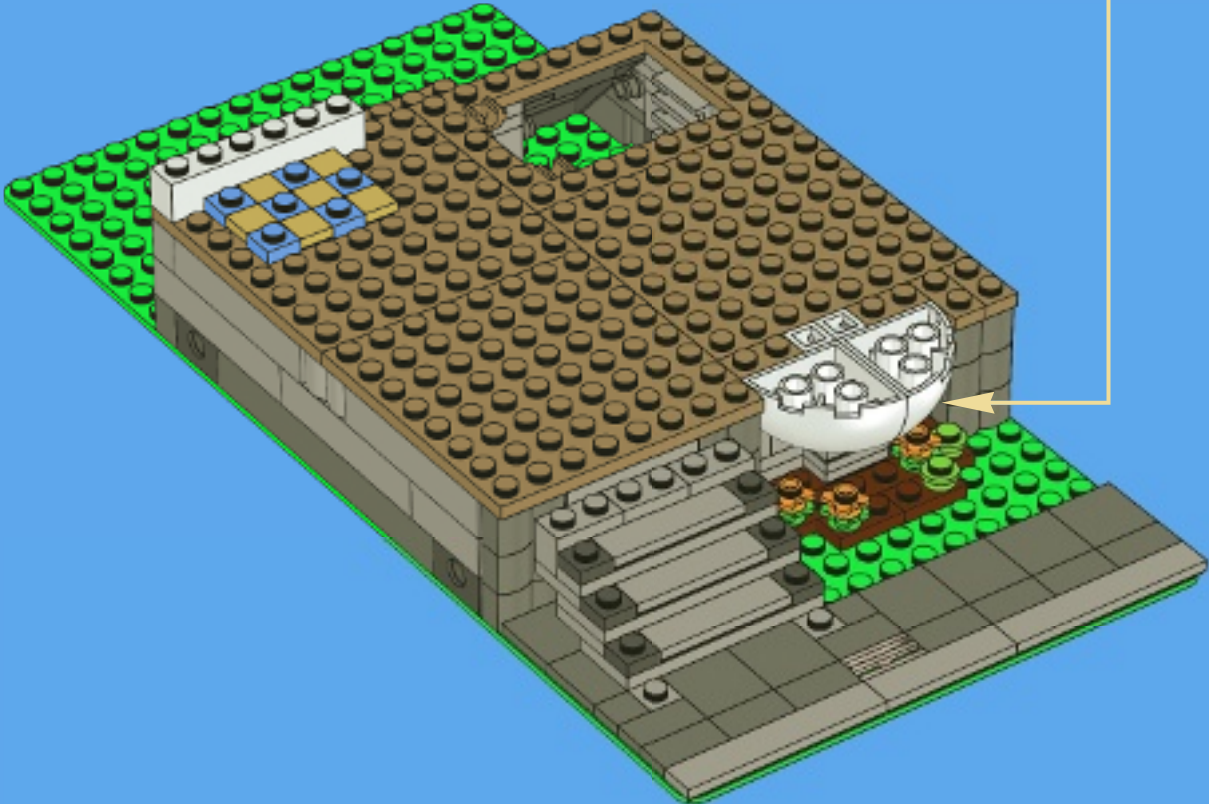
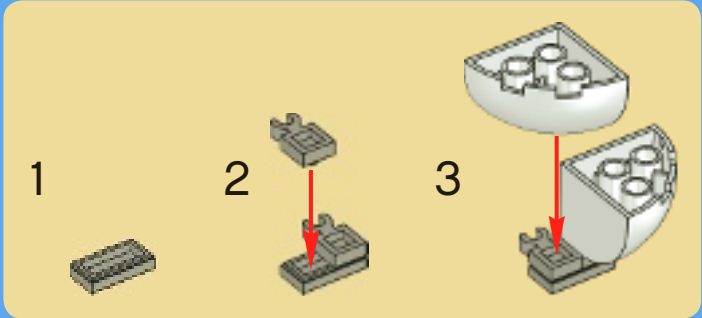







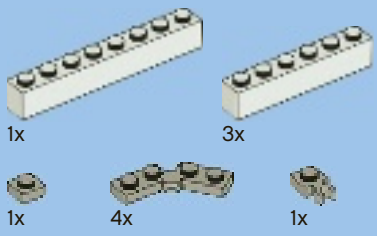

16

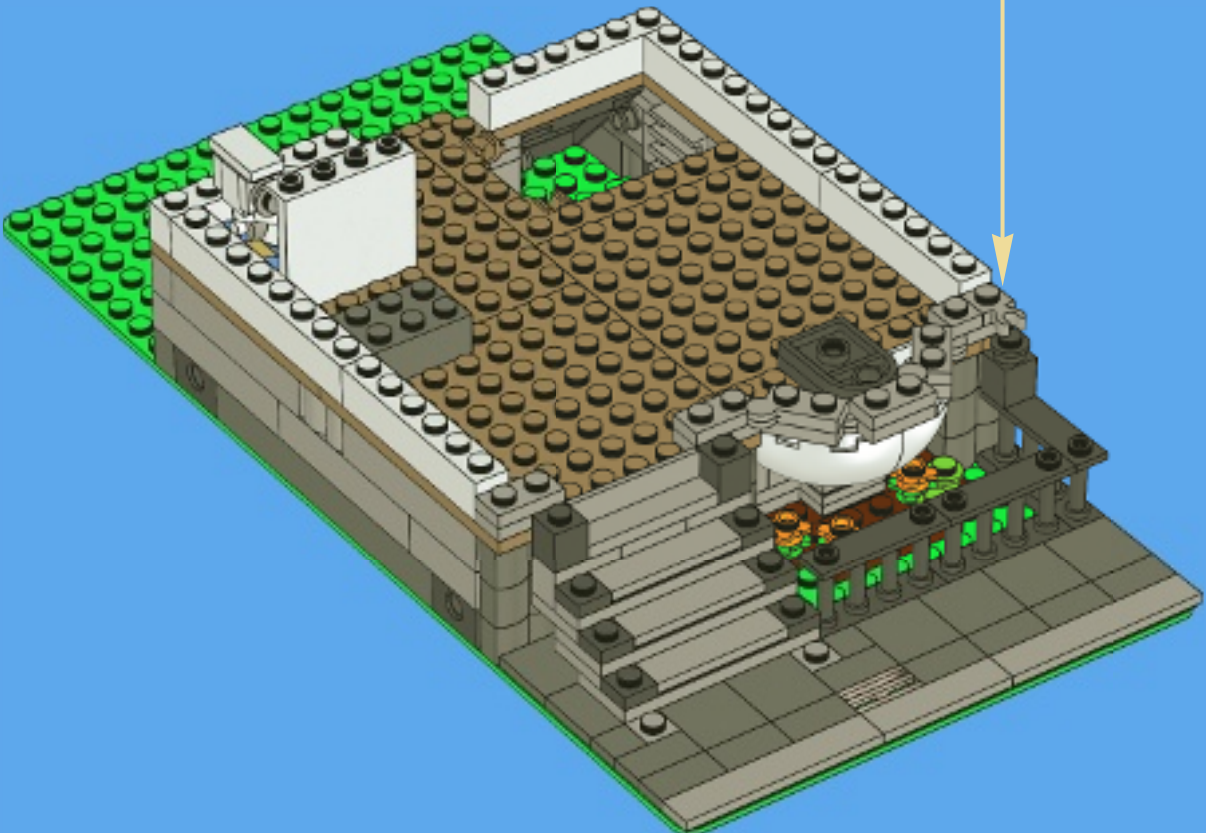
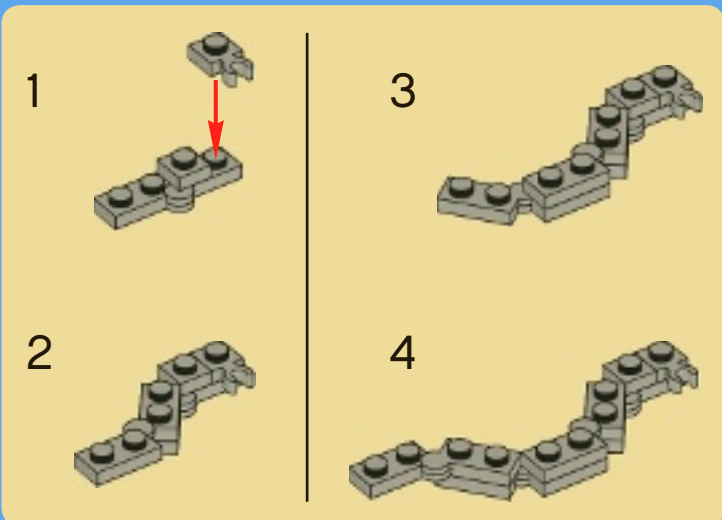



3x



1x



1x



6x



2x



4x

# 17

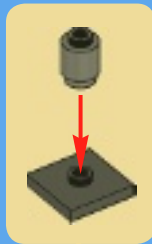

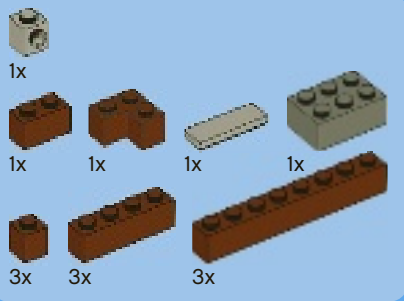

# 18



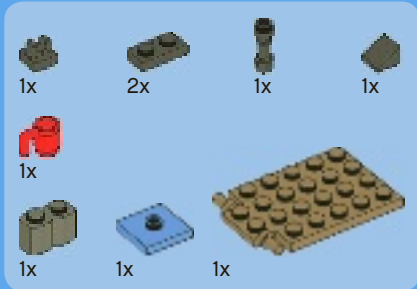

# 19

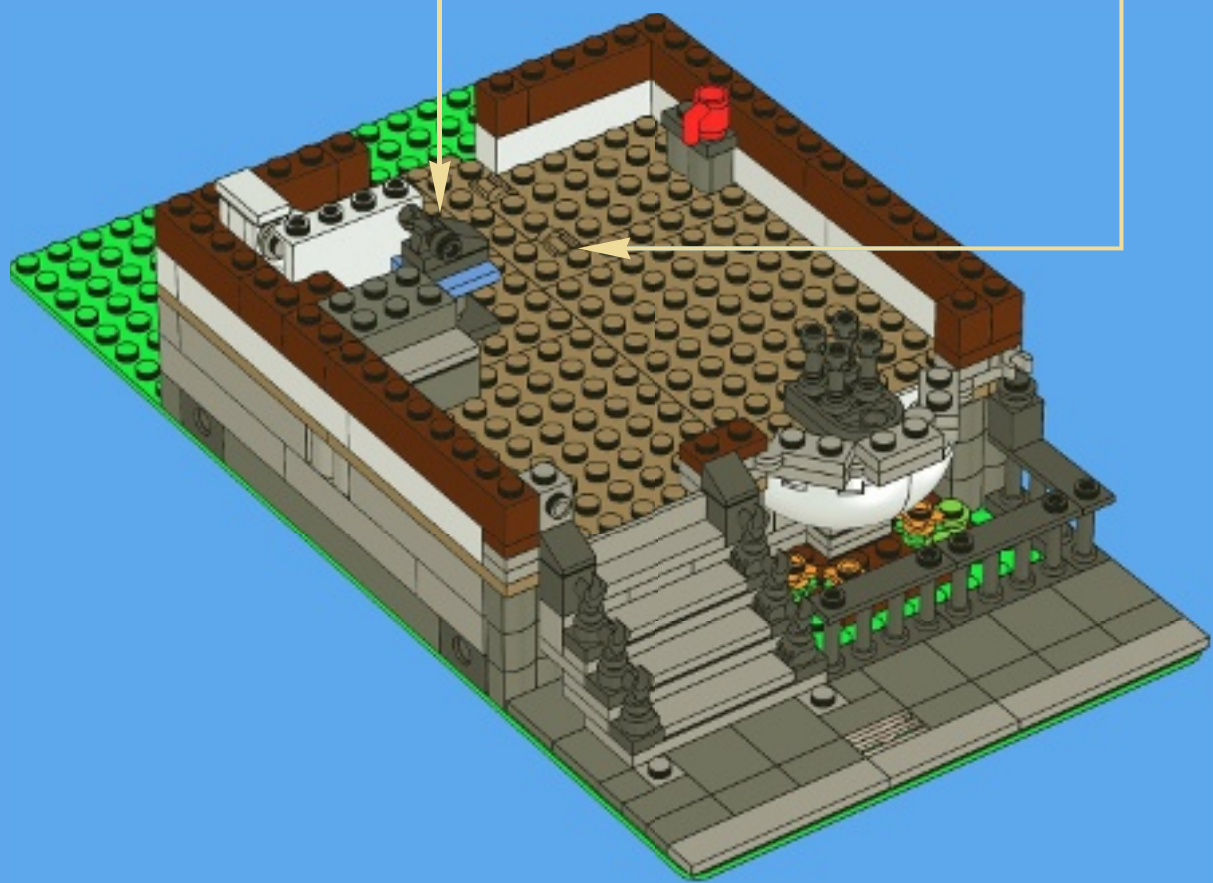
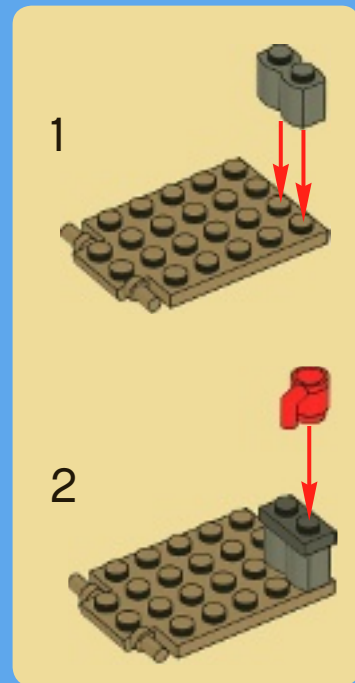
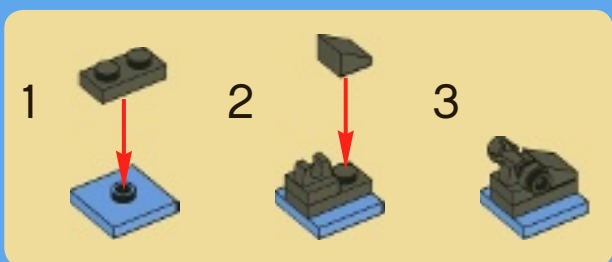



1

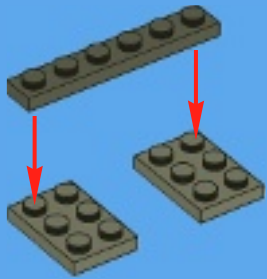

2

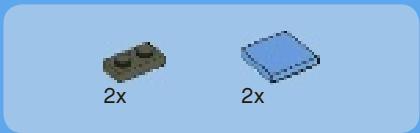
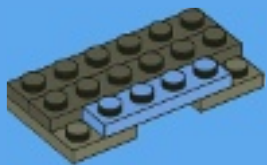

3

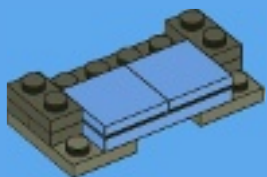

4

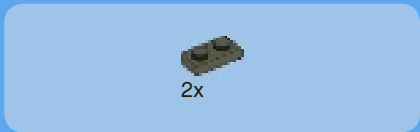
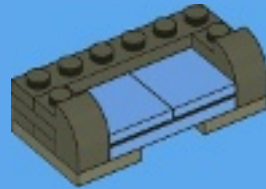

5

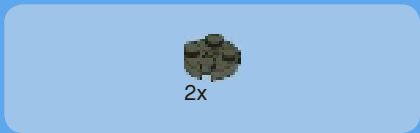
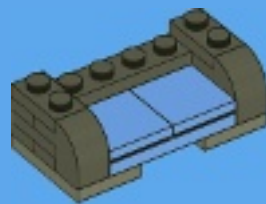

6





1x



2x

7

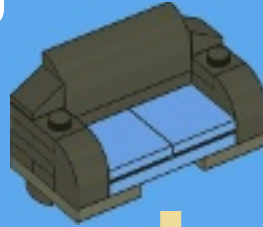

20



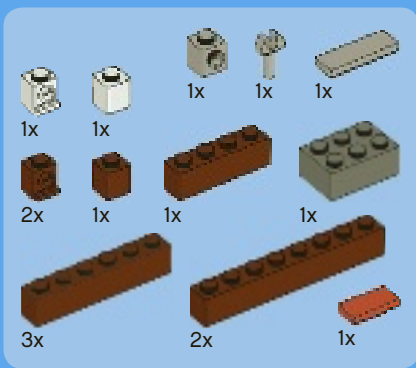

# 21

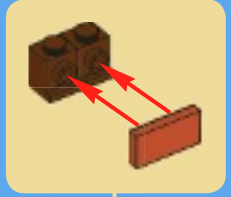
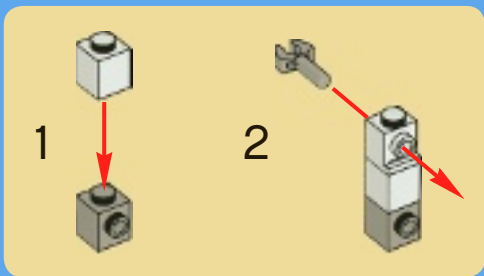





# 22

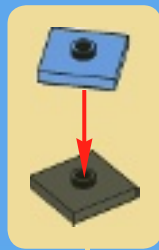
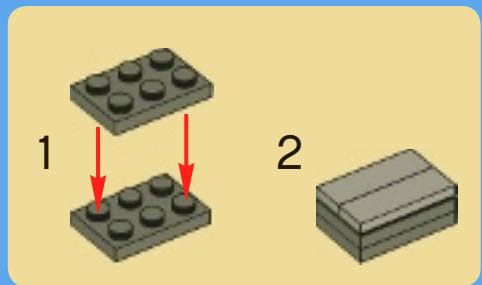

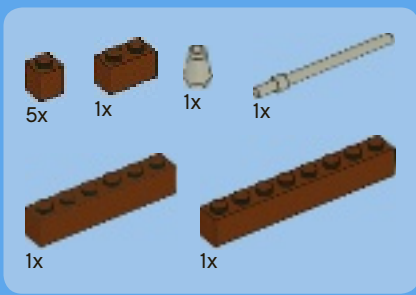

23

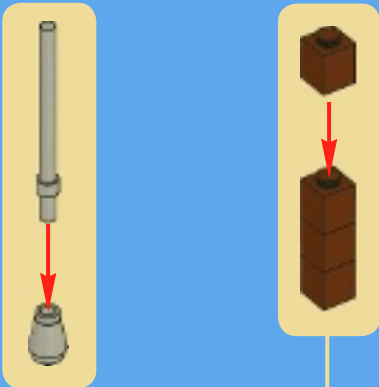

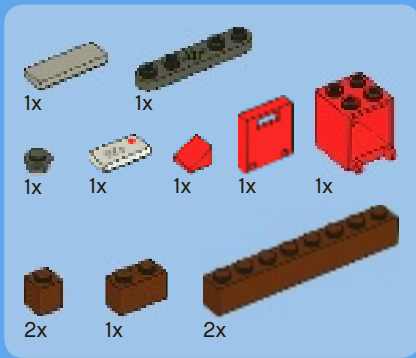

# 24

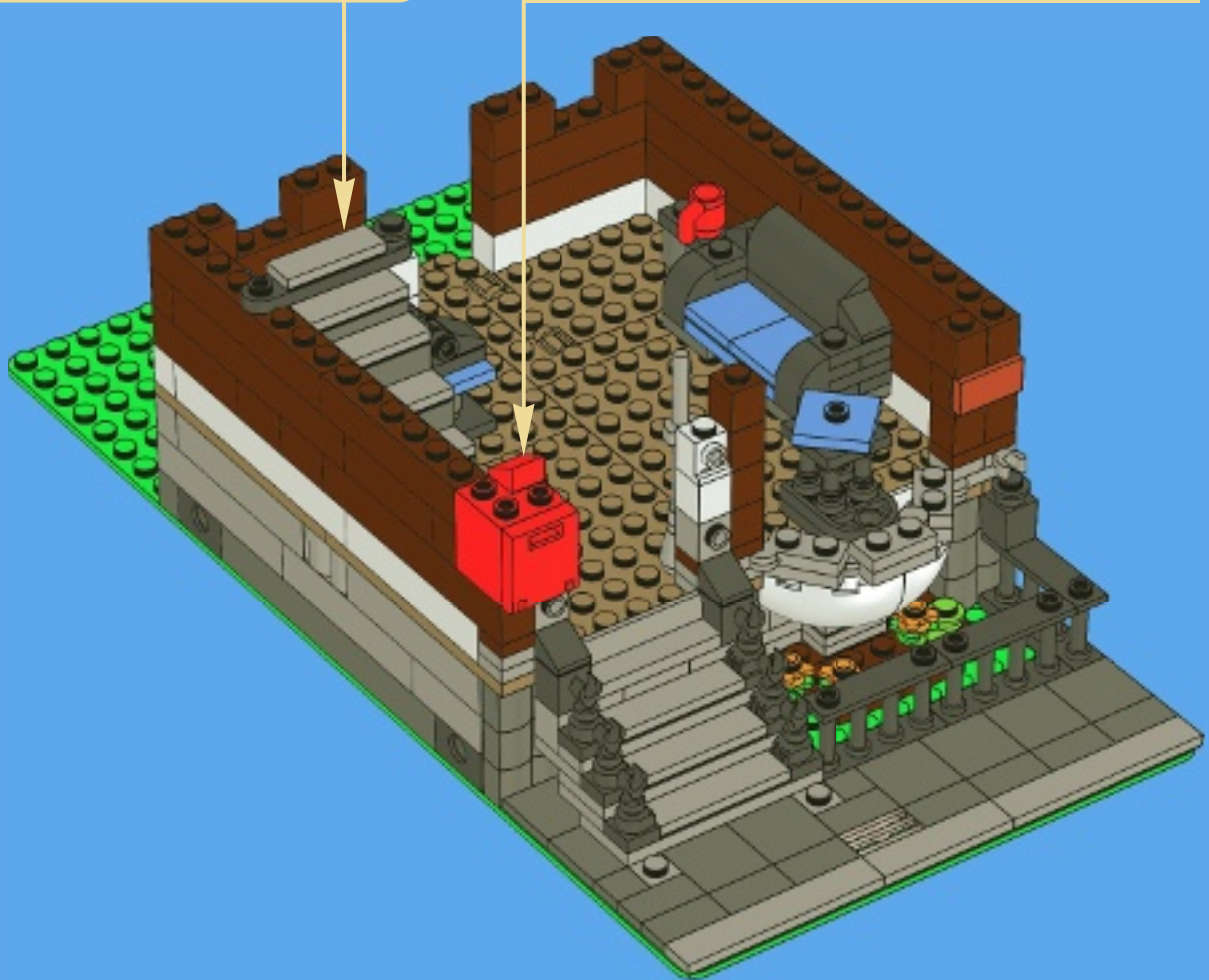
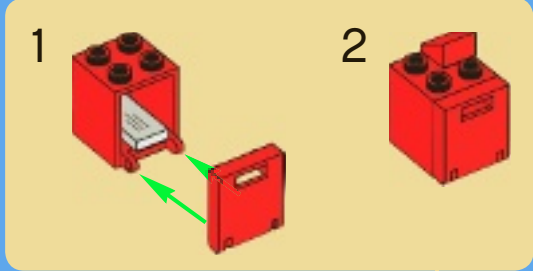
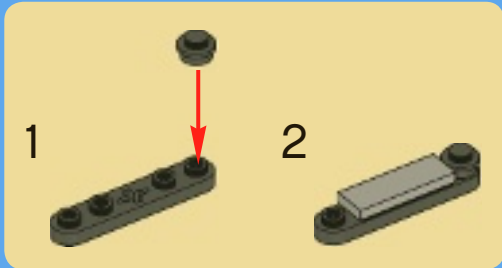

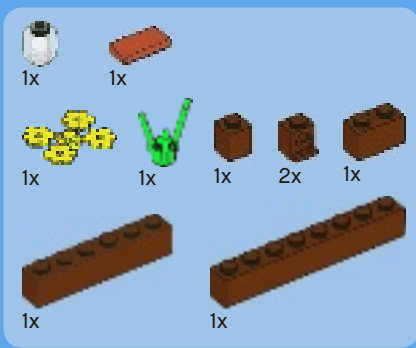

25

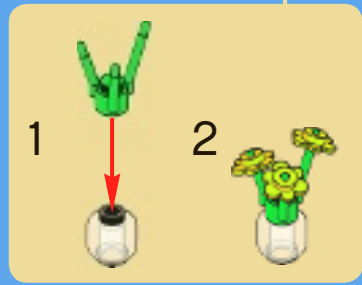
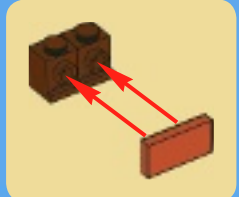
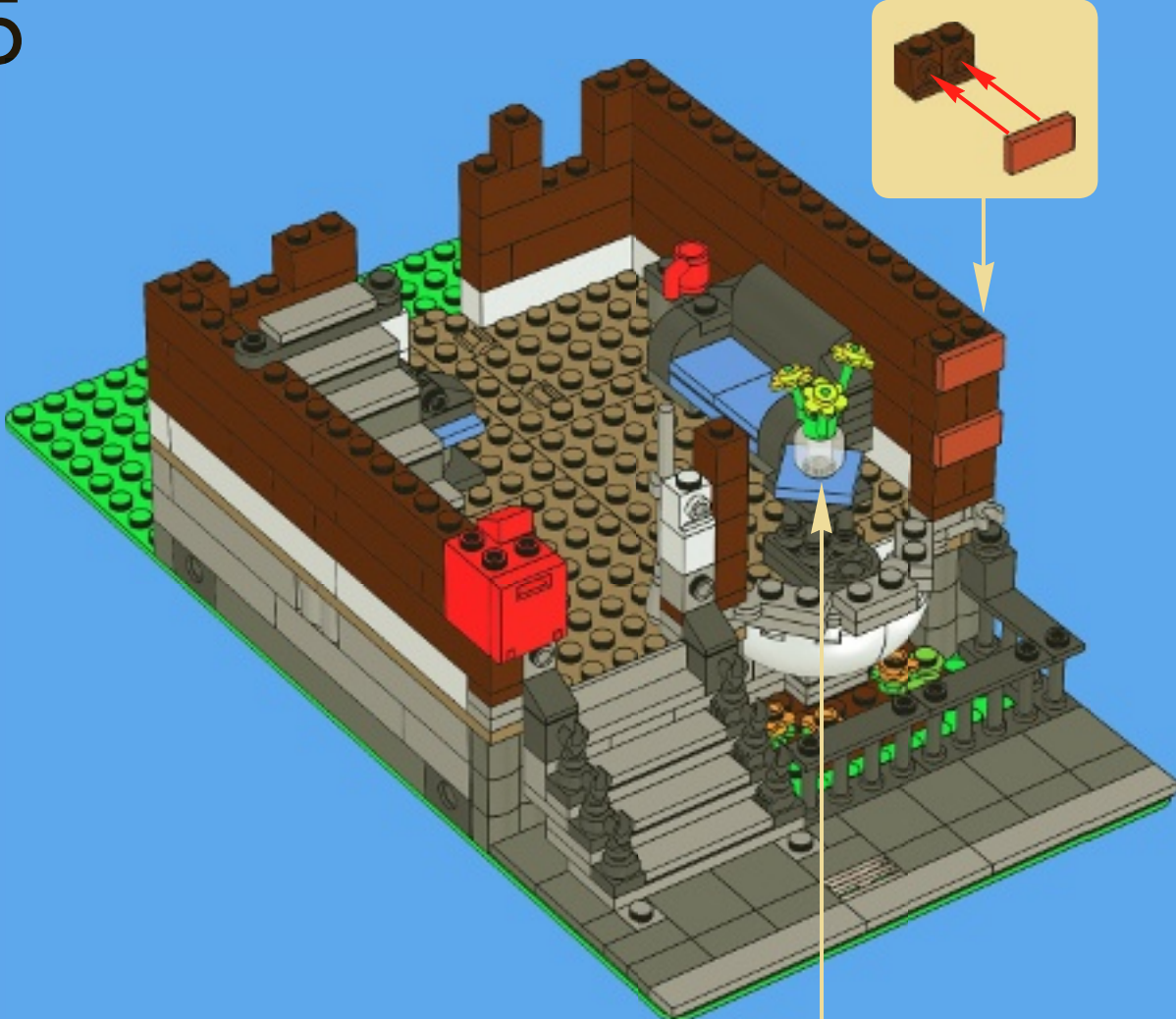



26

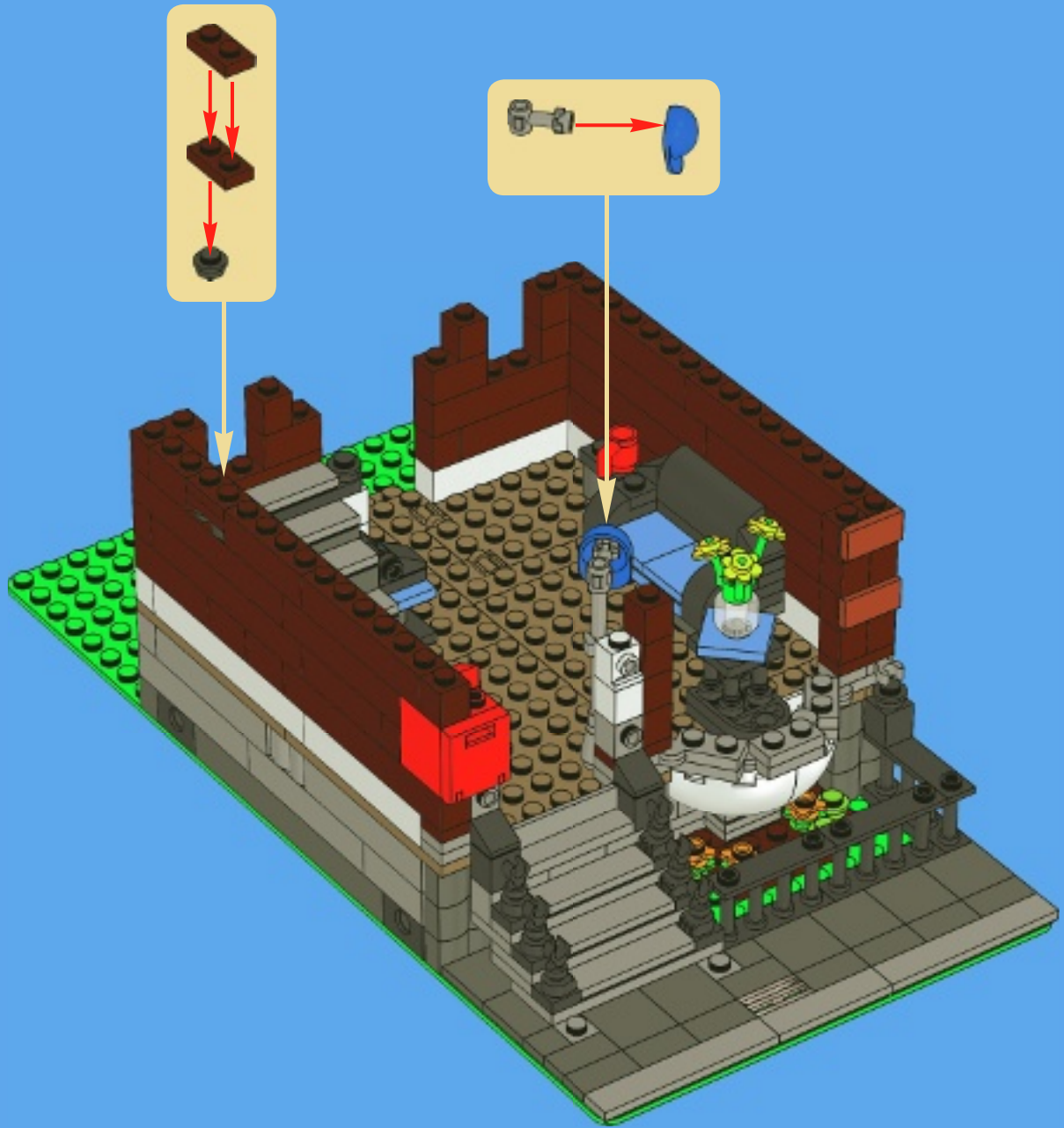



2x



2x

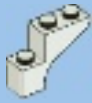

4x

# 27

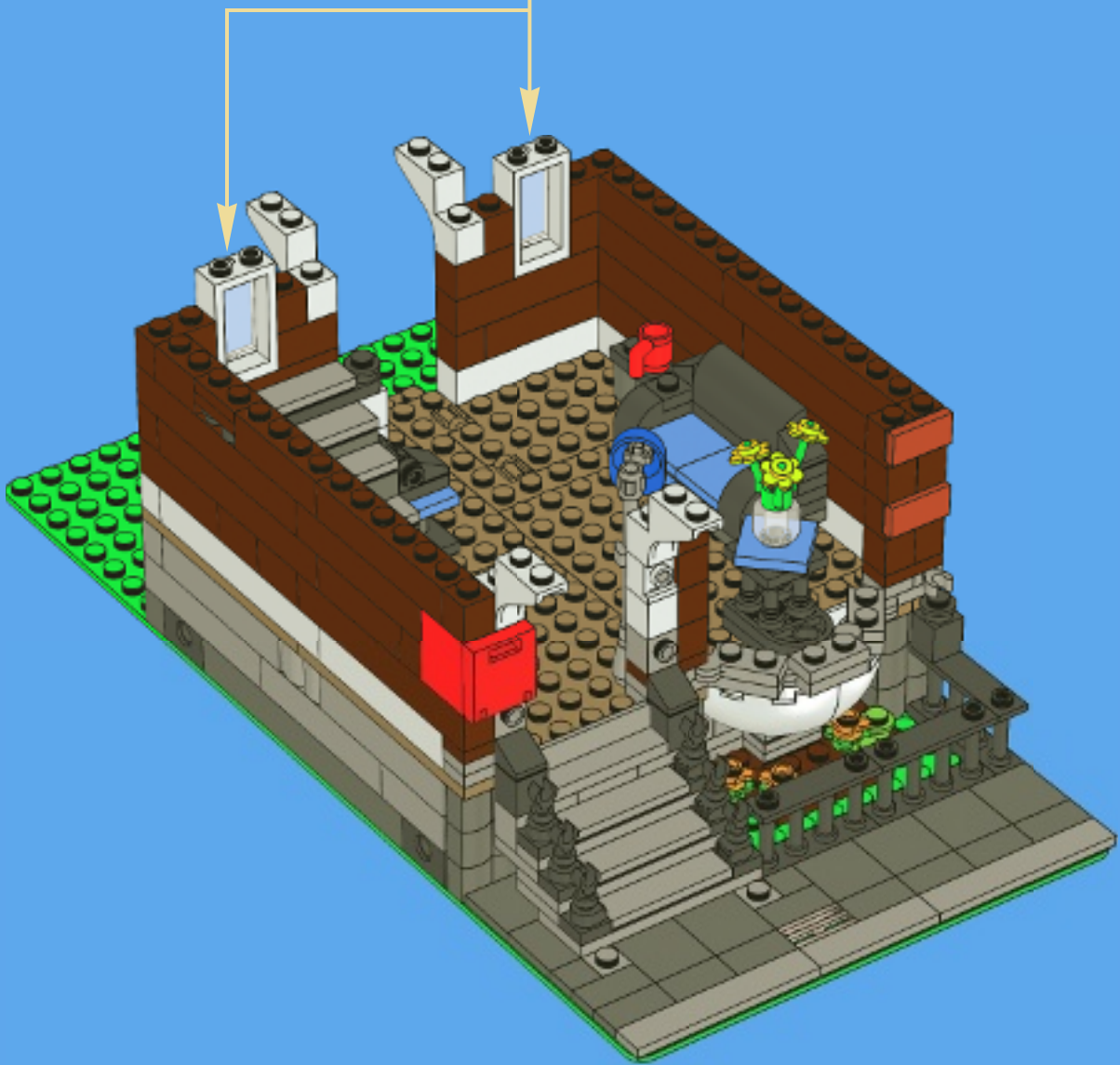
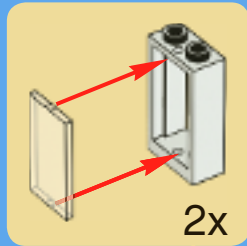

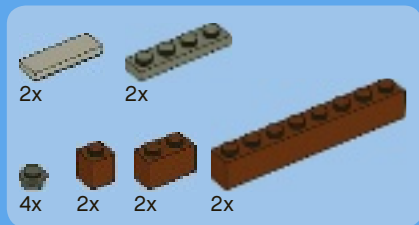

# 28

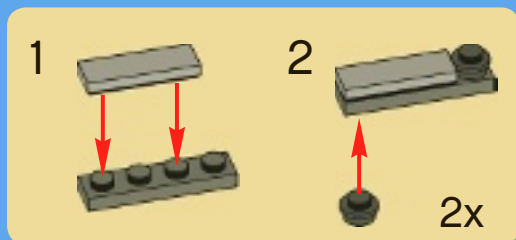

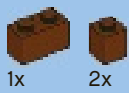

1x 2x

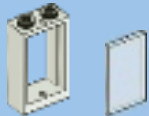

6x 6x



2x

# 29

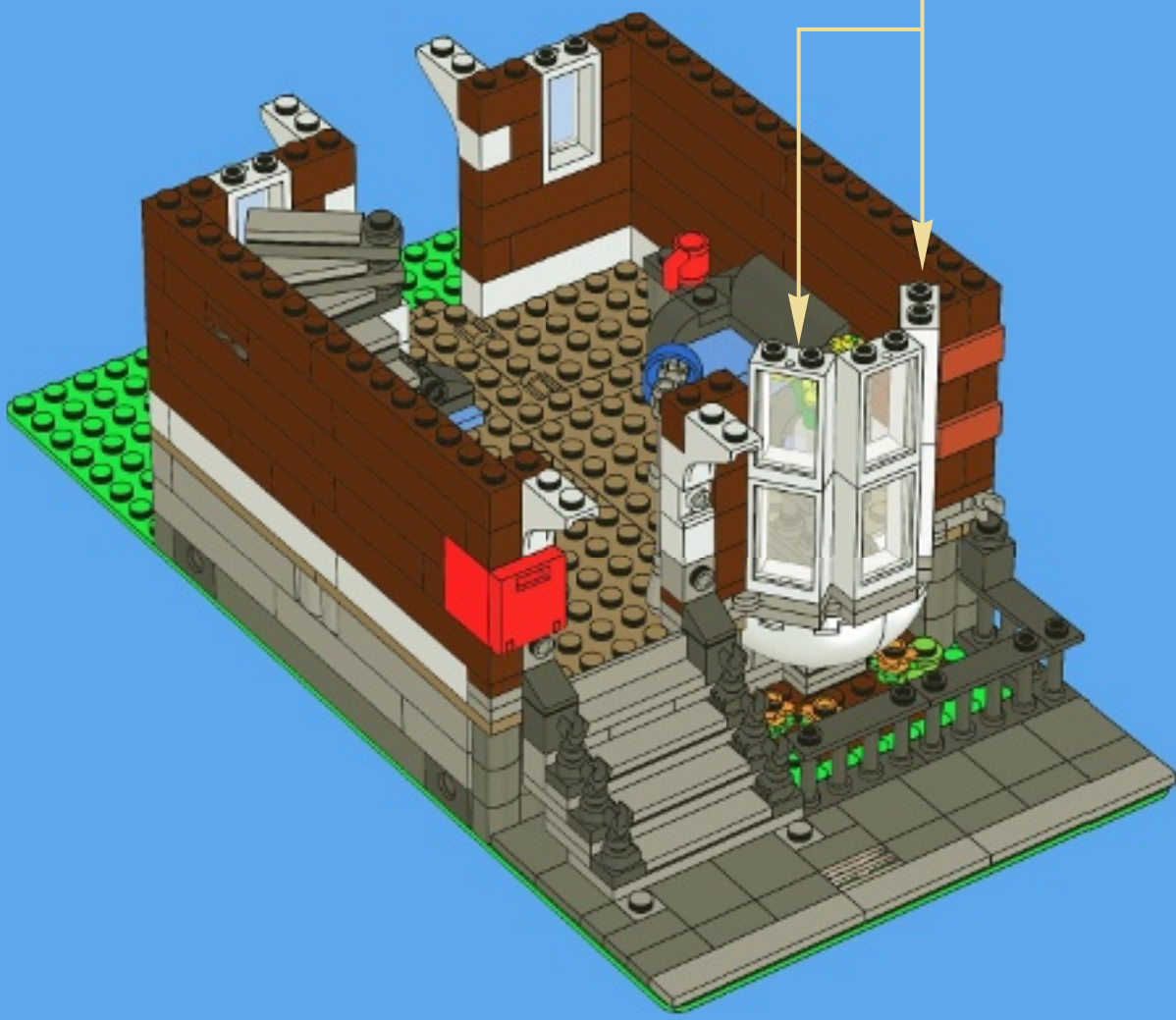
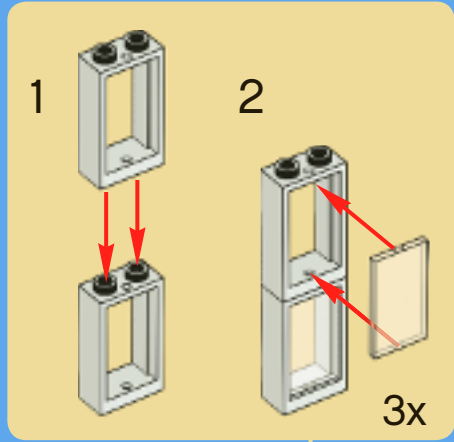



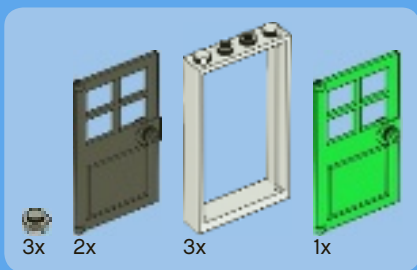

# 30

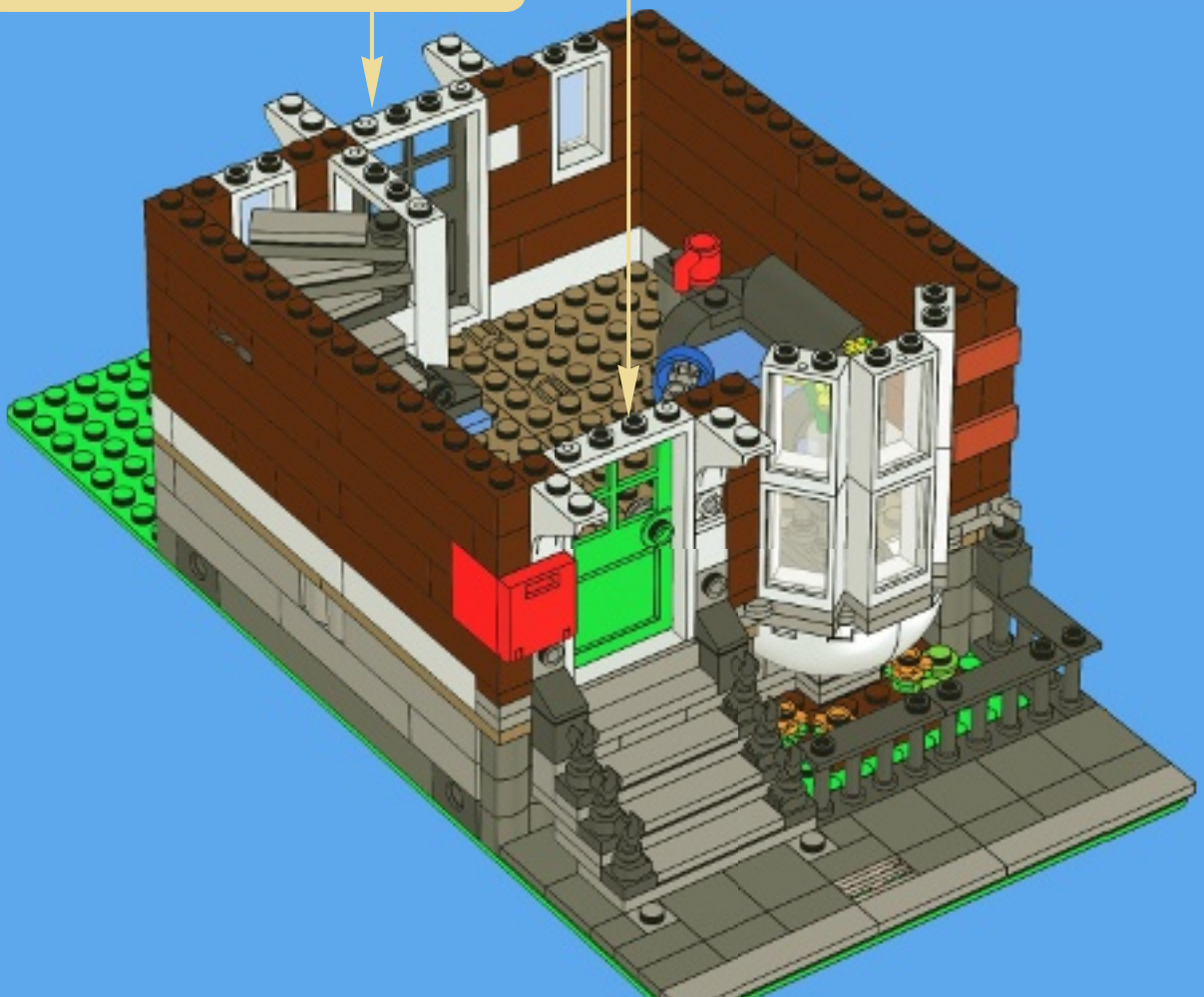
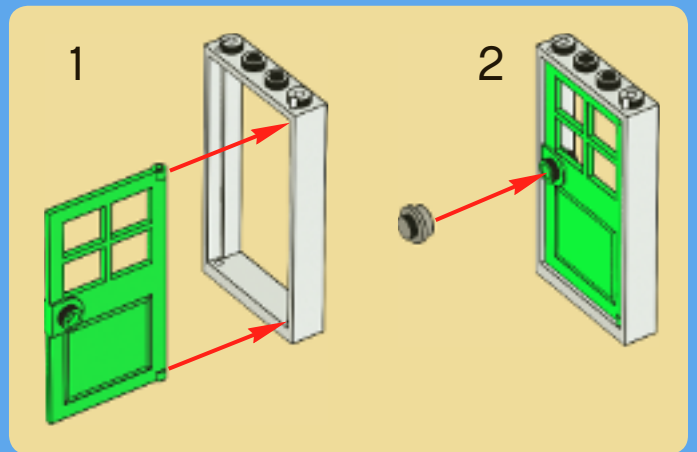
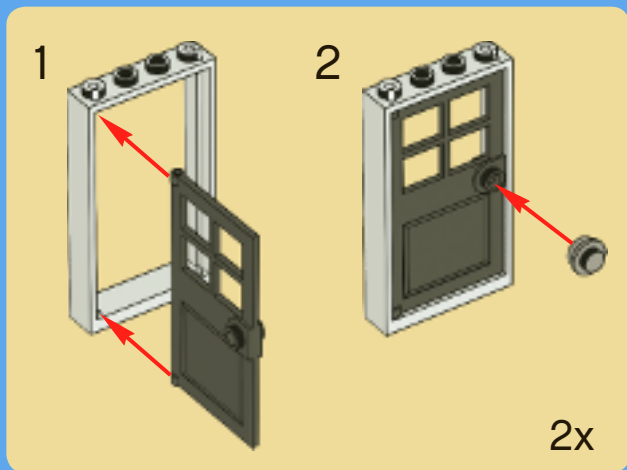

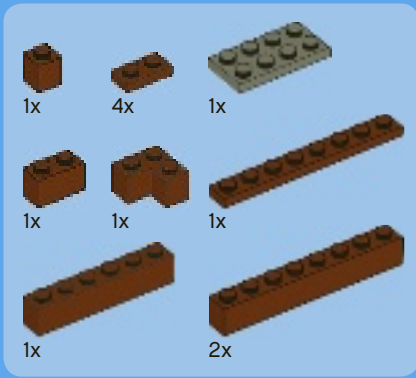

# 31

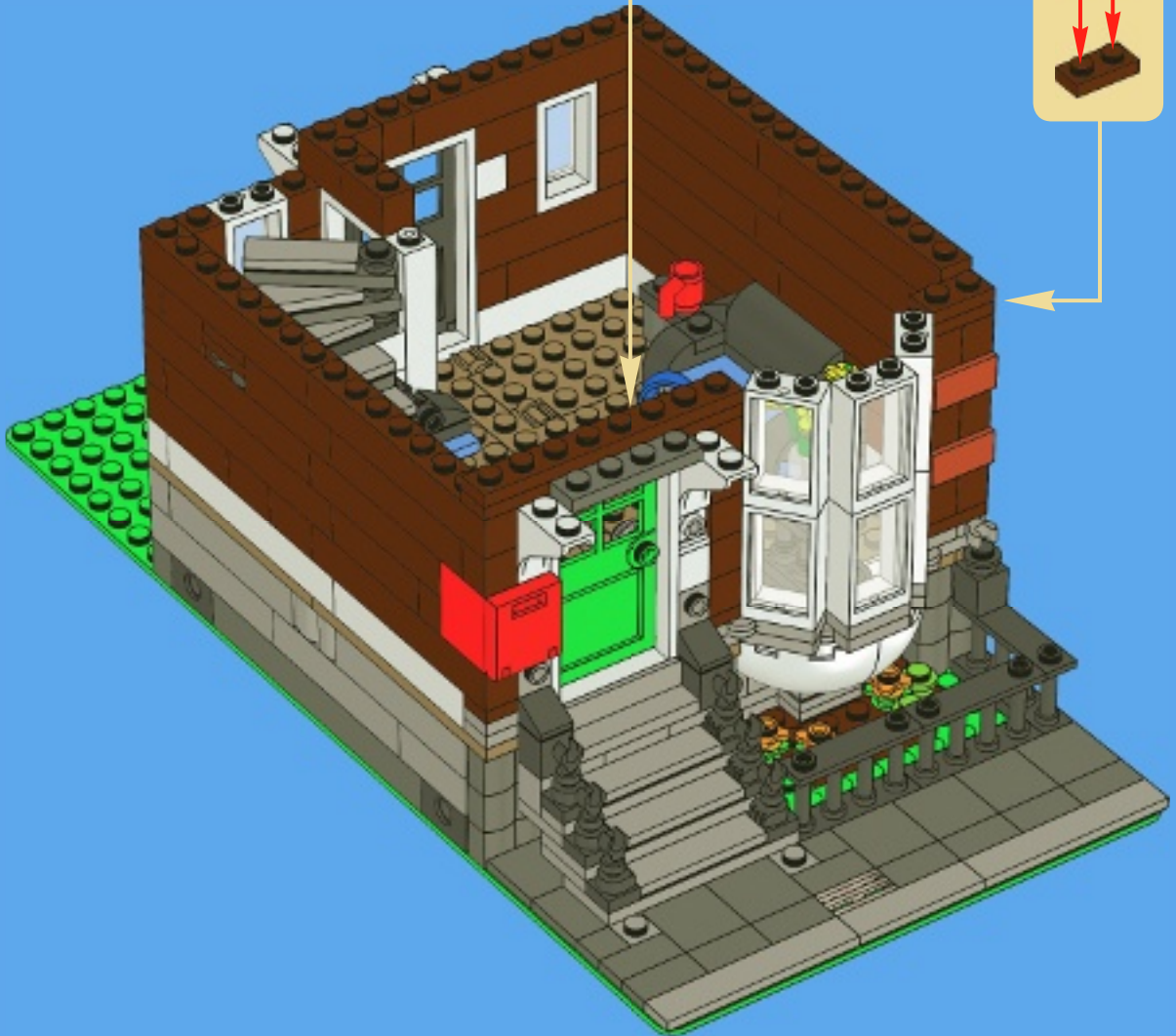
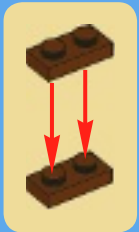

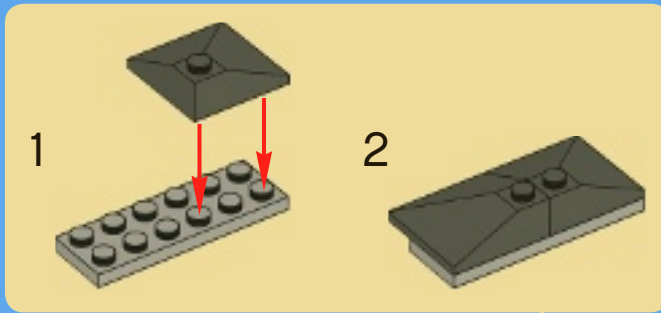
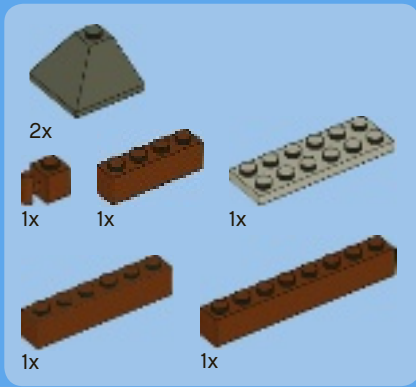

32

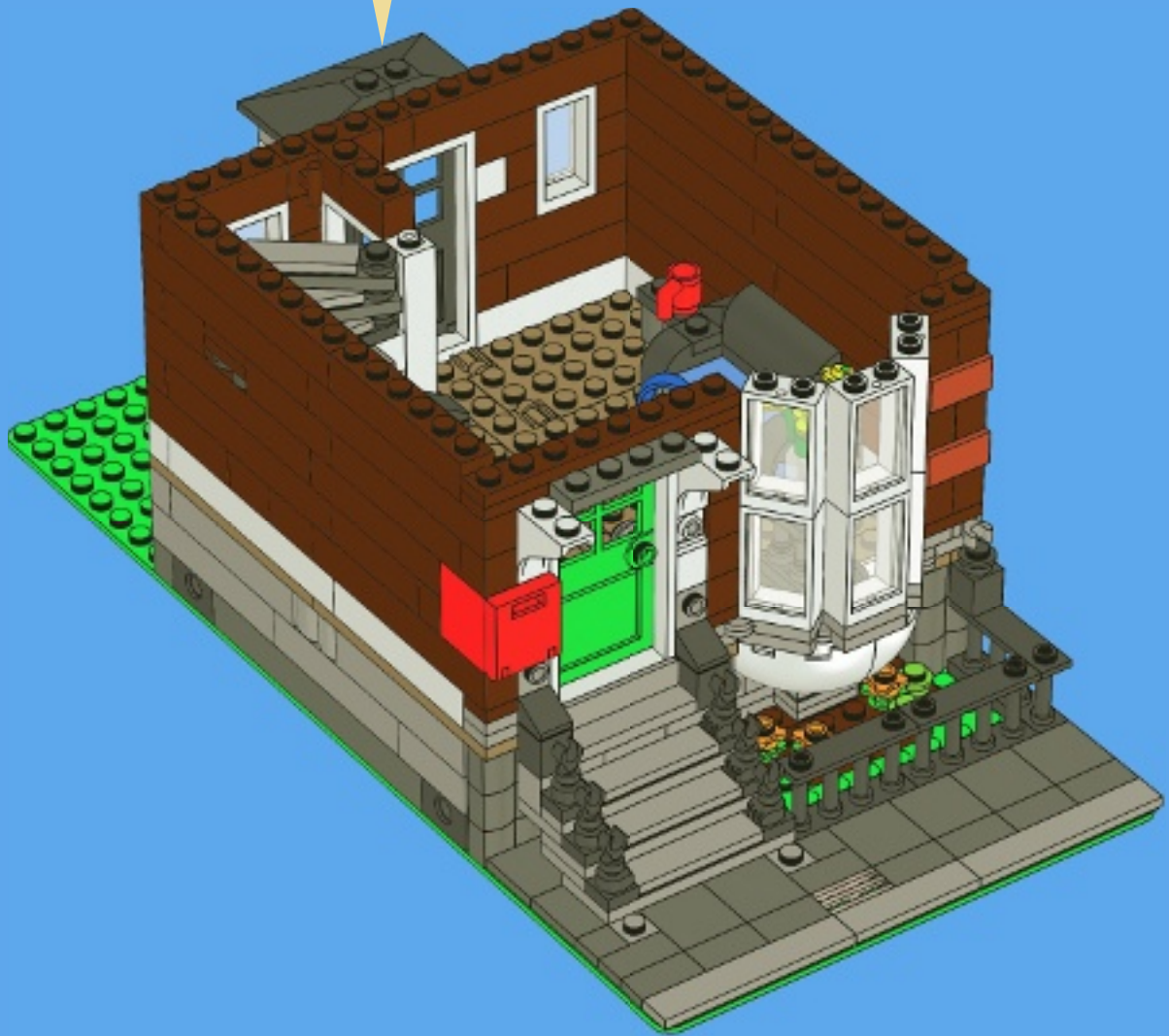

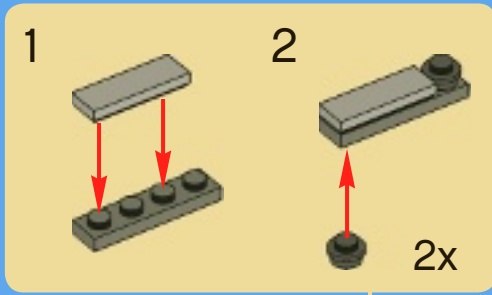
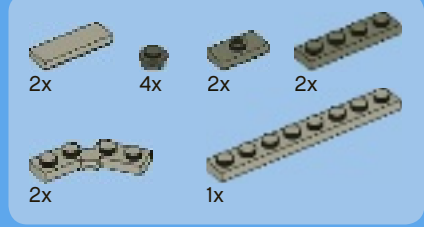

33

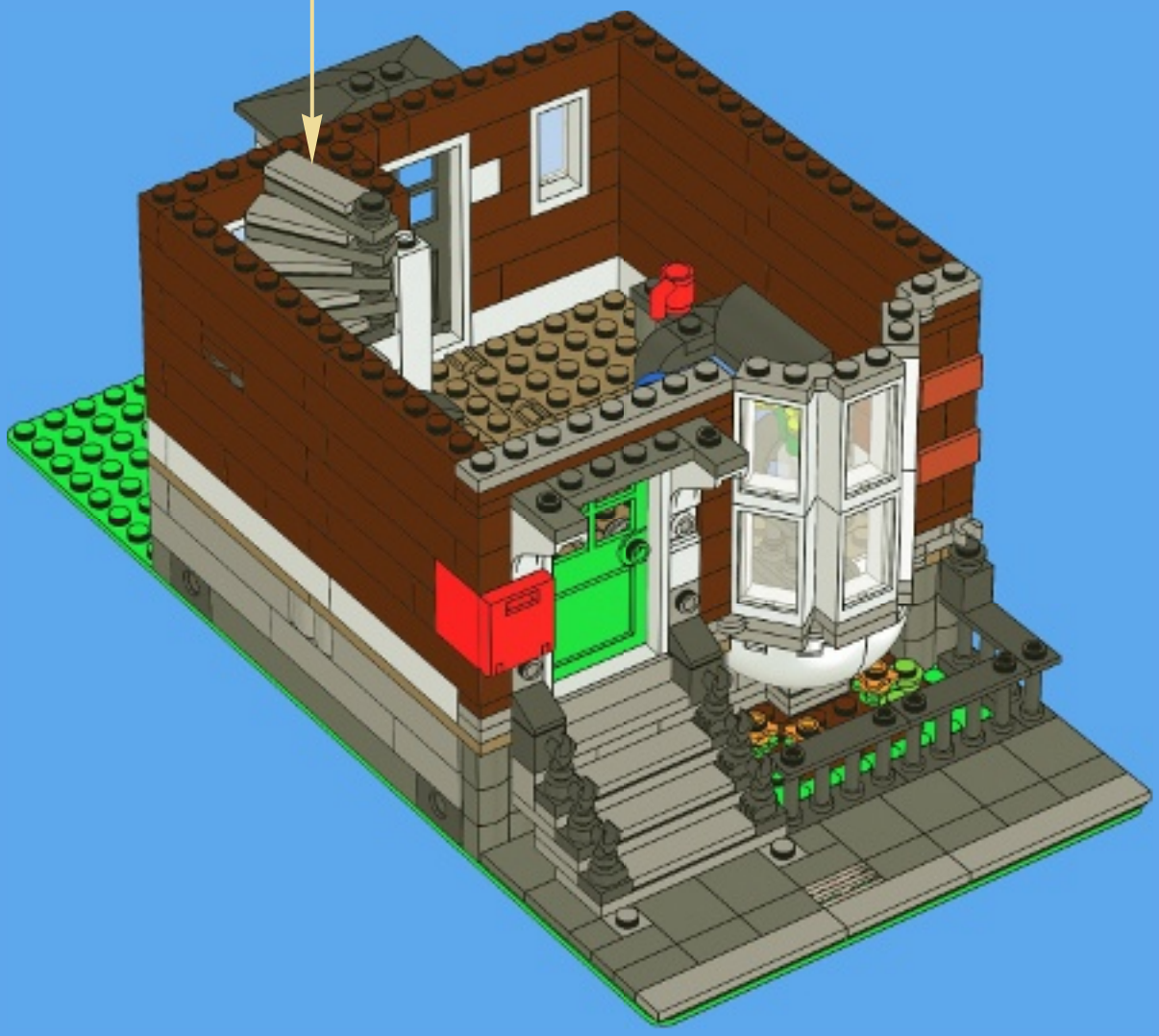



34

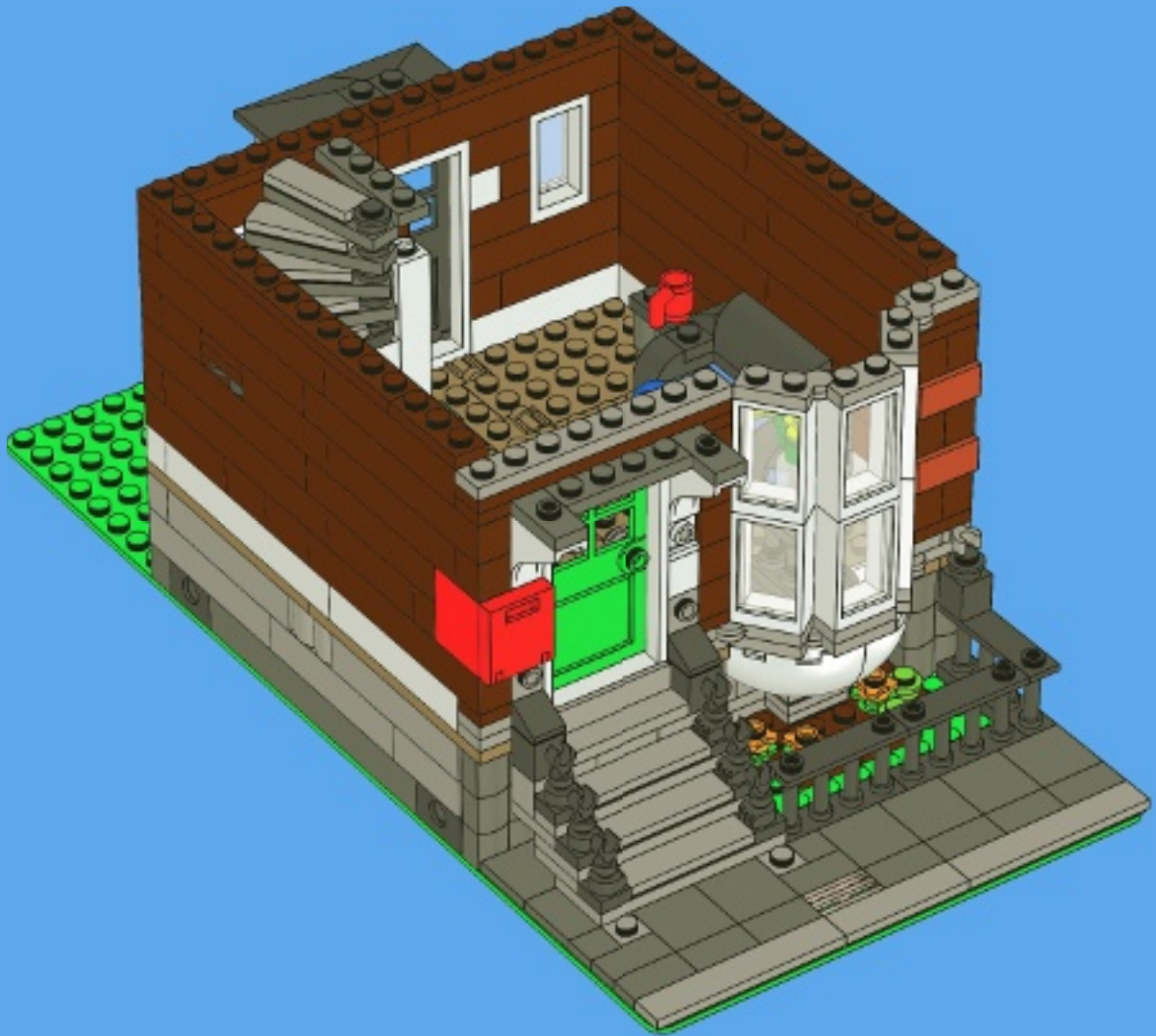

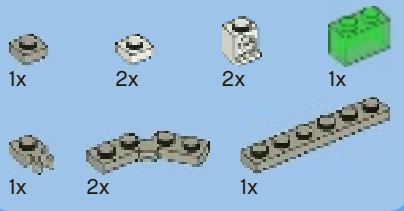

# 35

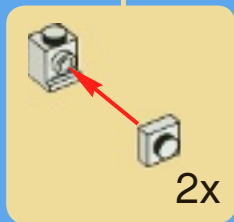
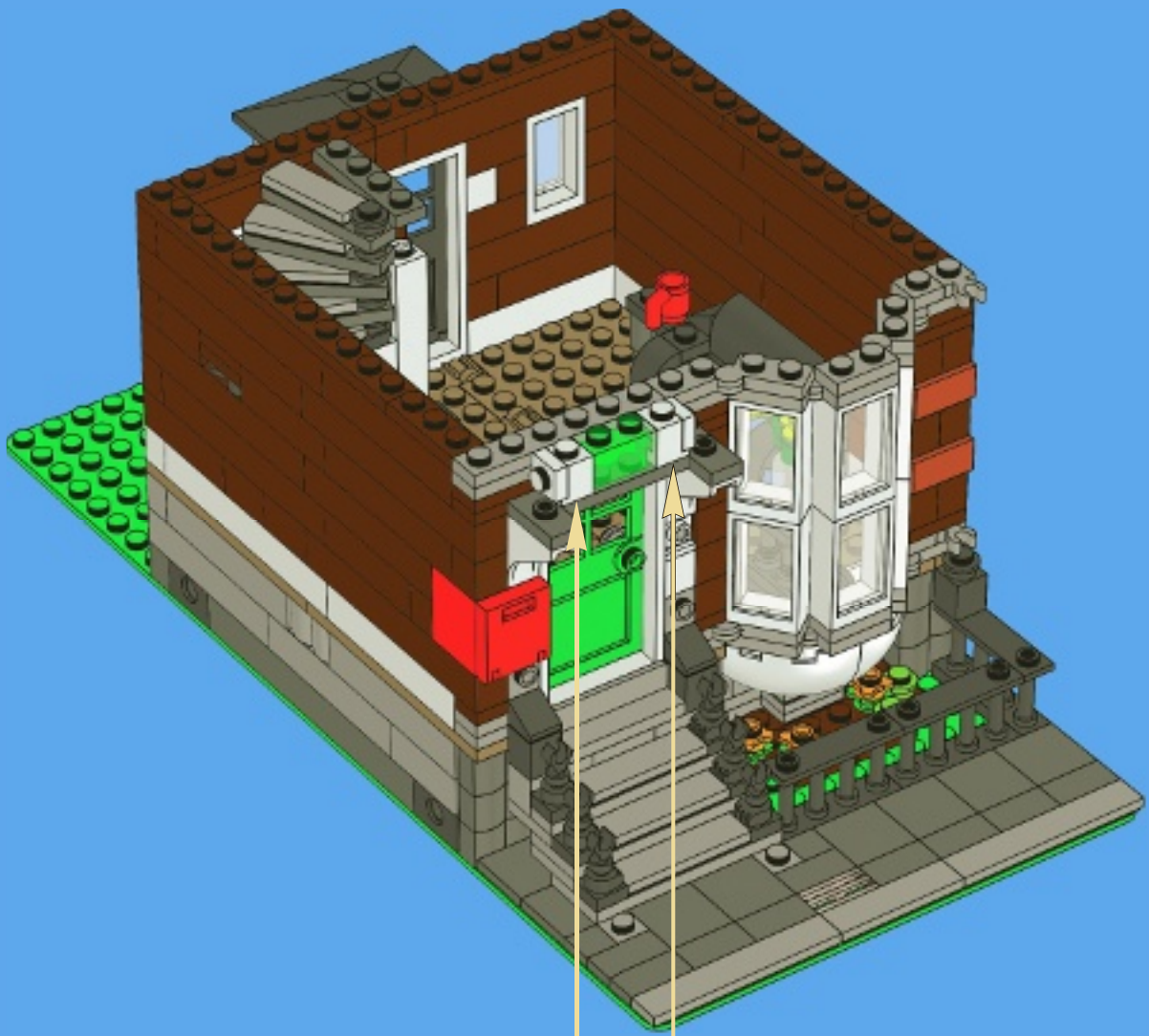

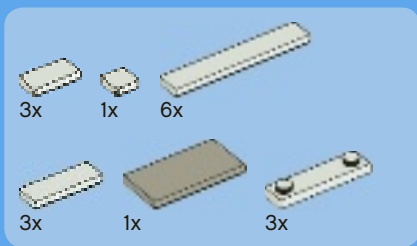

36

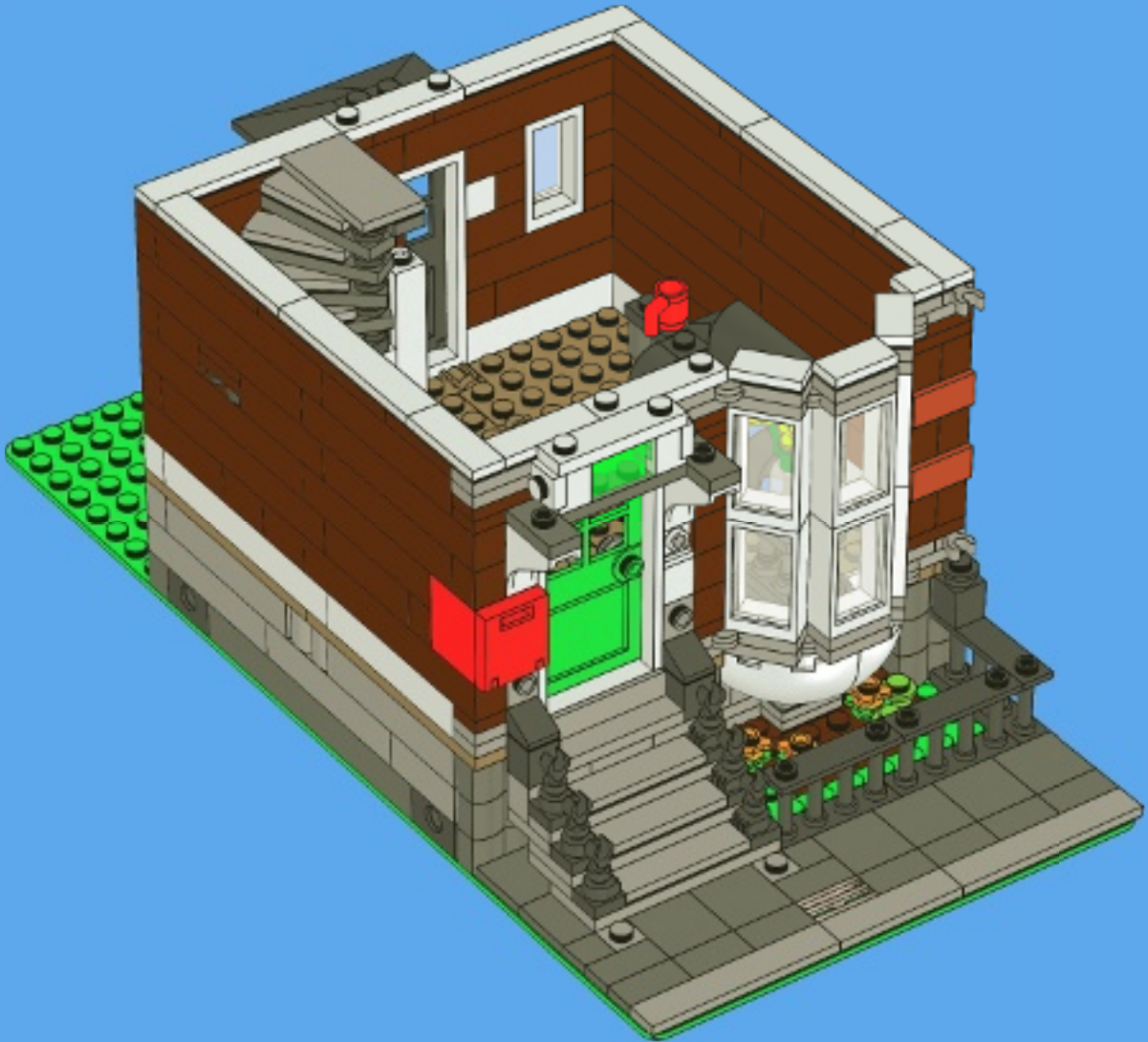



2x



4x



2x

# 37

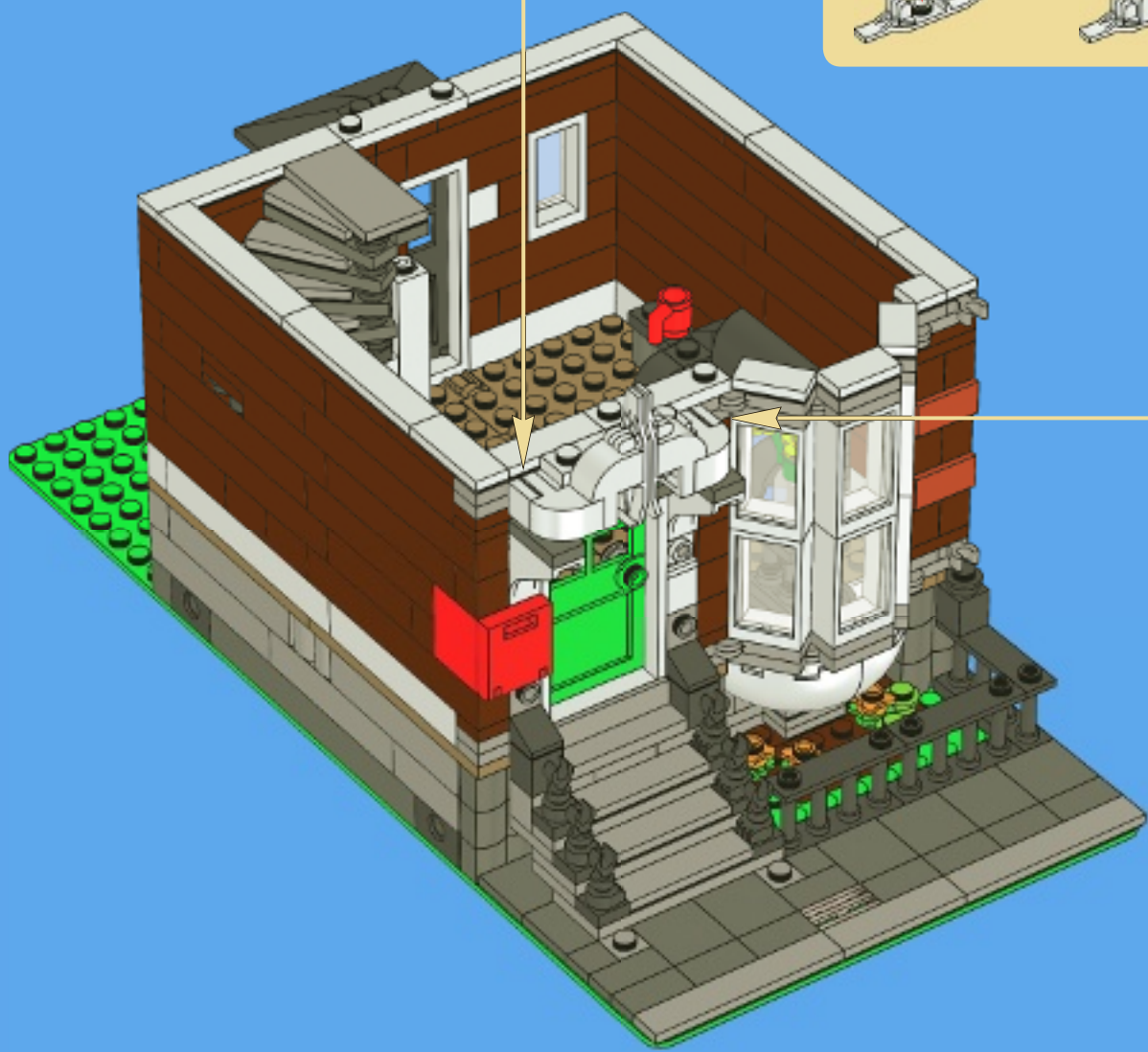
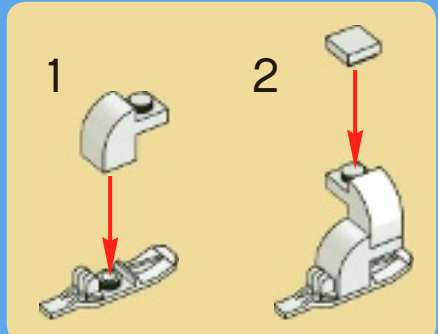
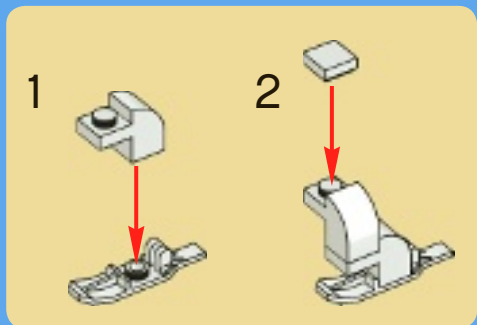



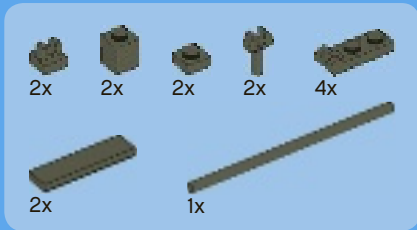

38

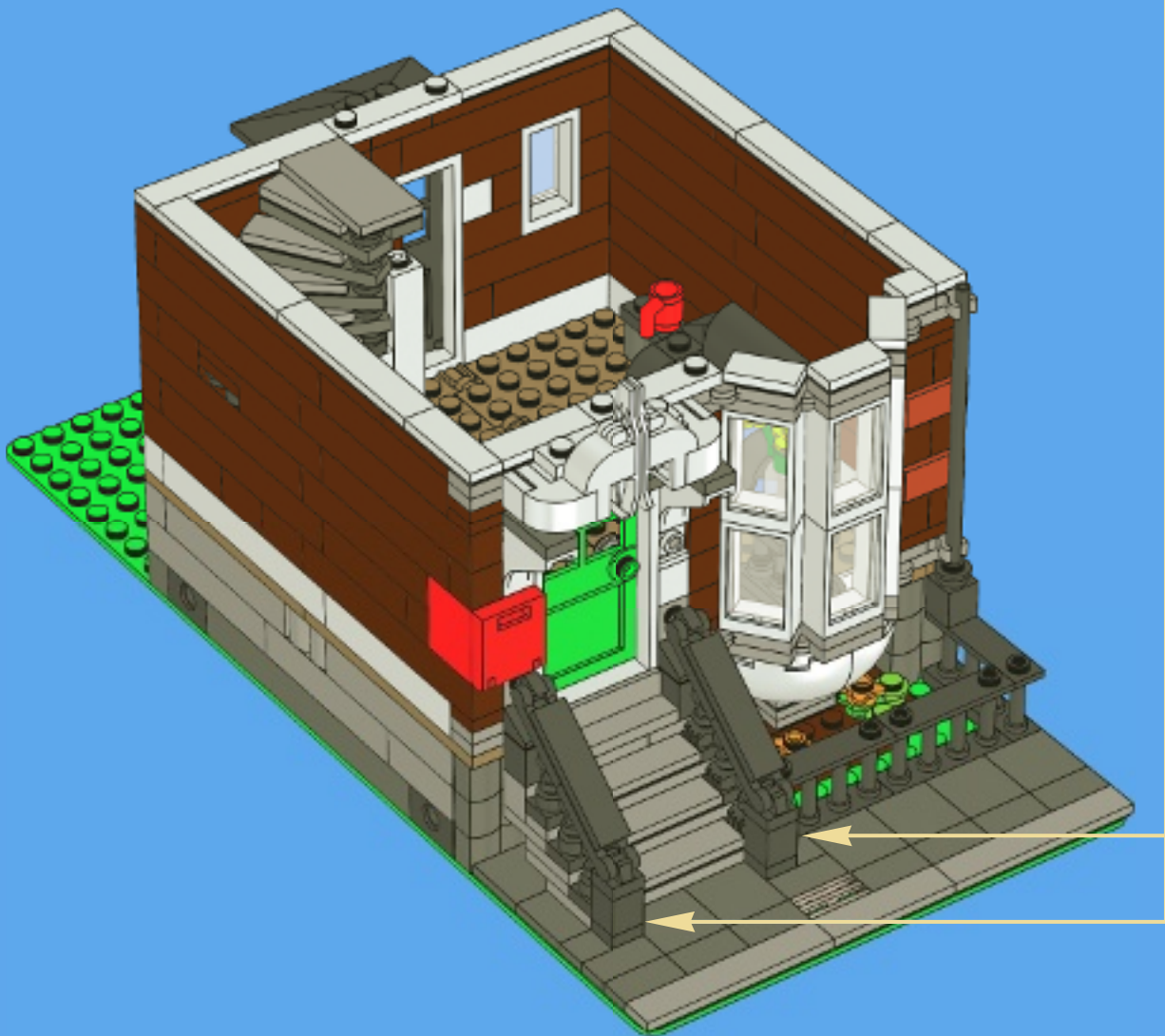
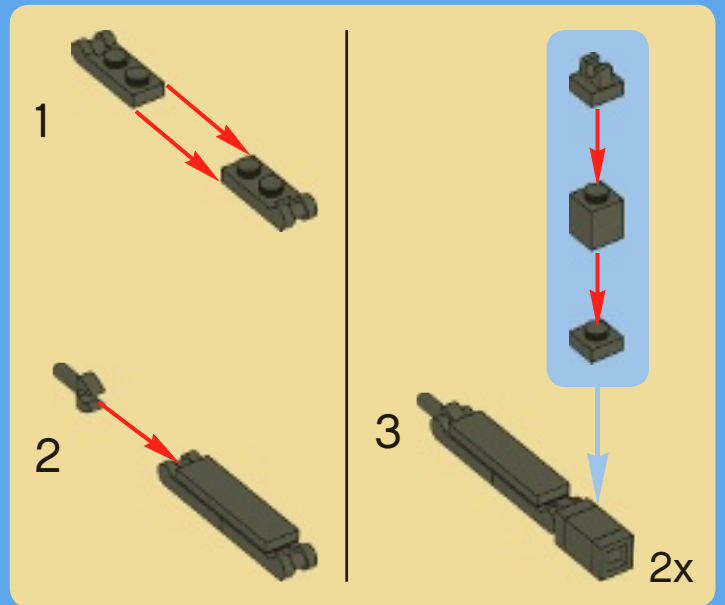

39

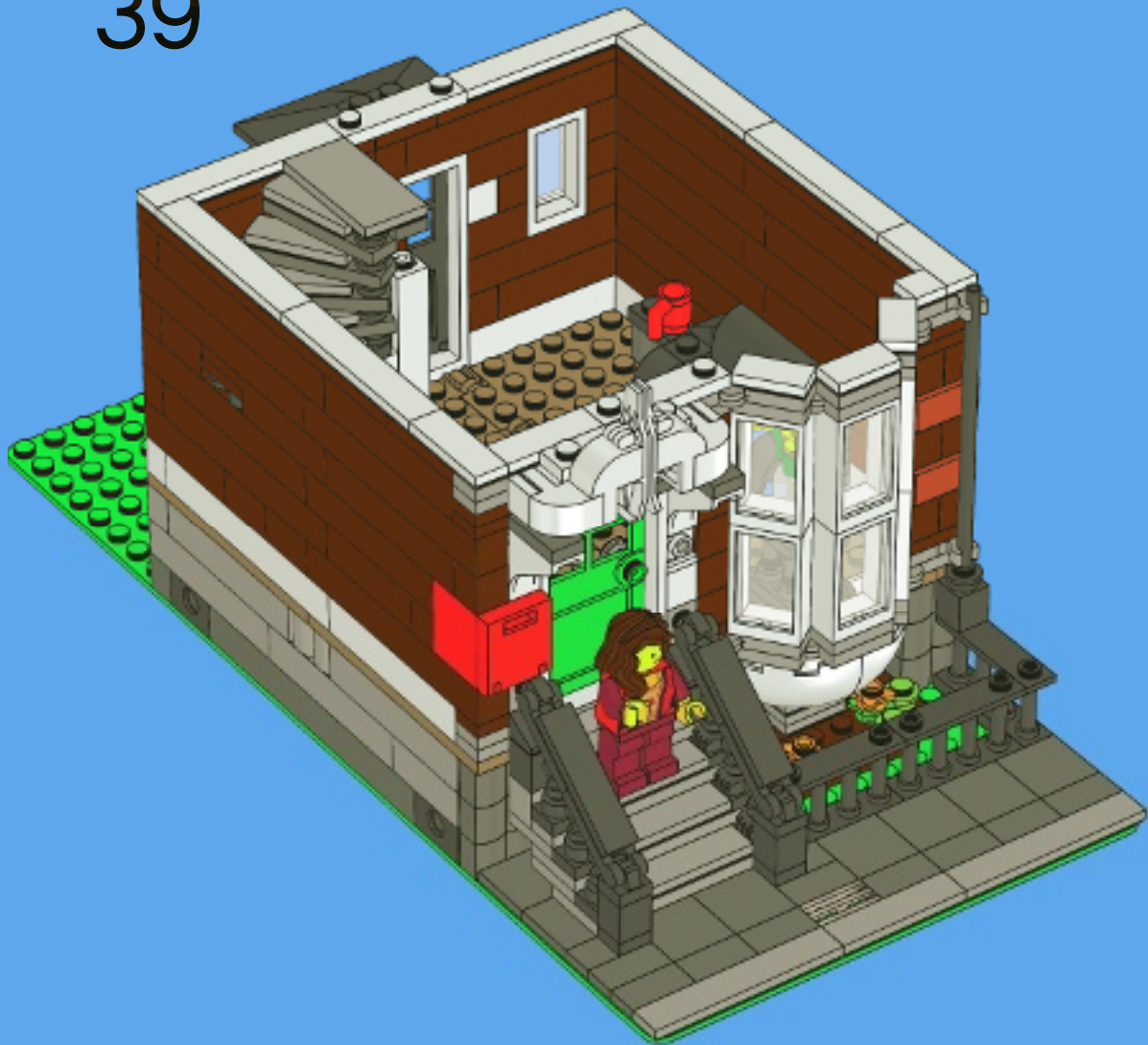

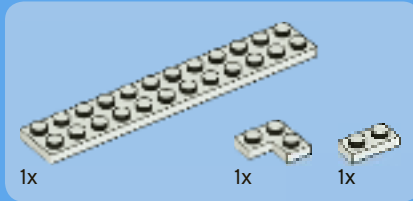
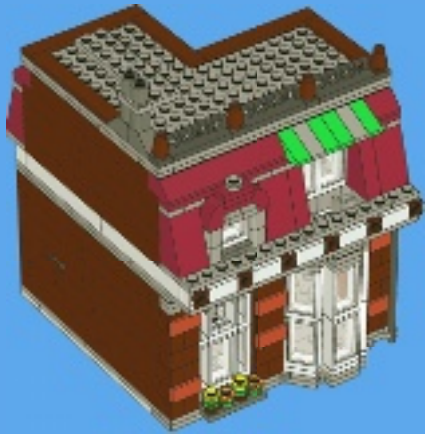

1

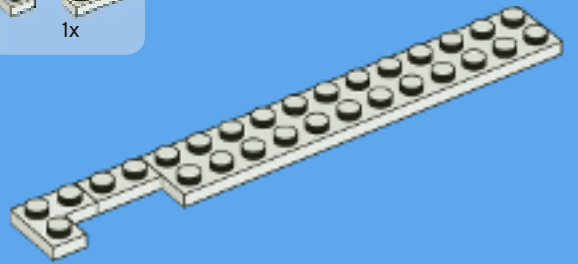

2

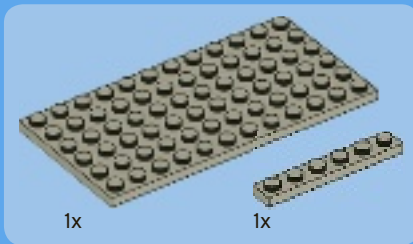
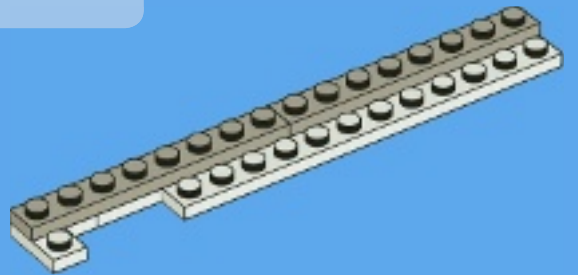

3

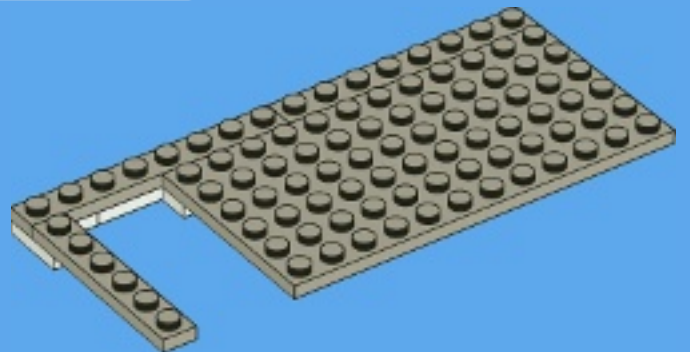

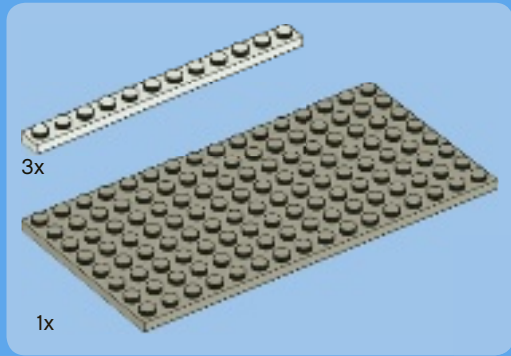

4

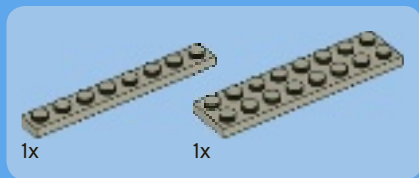
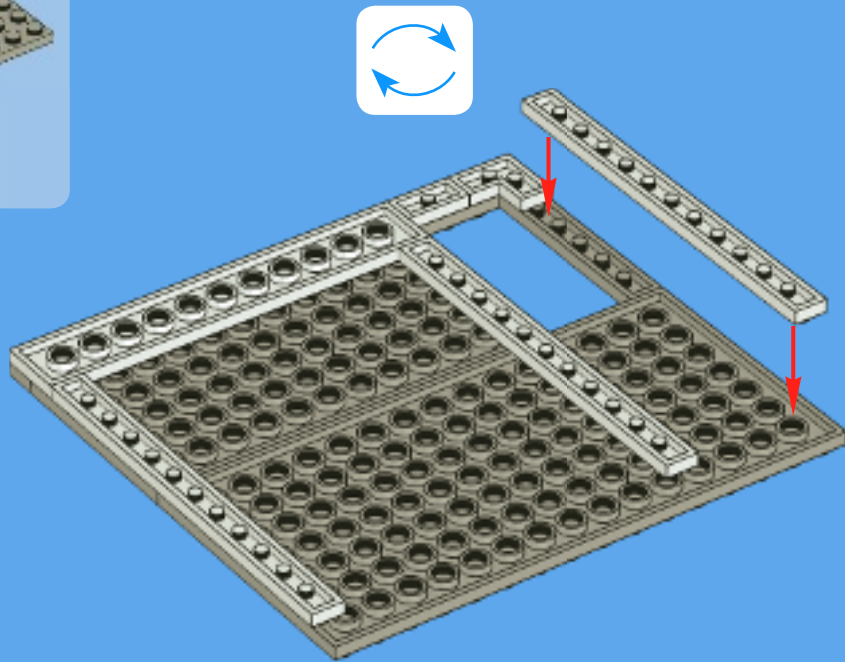

5

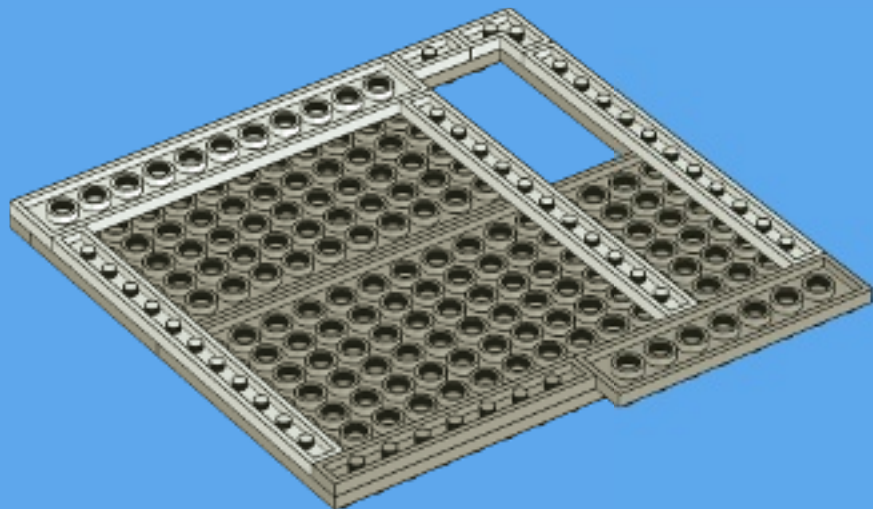

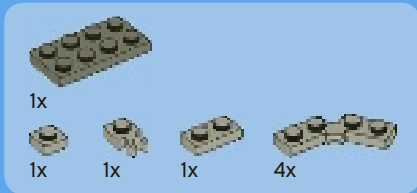

6

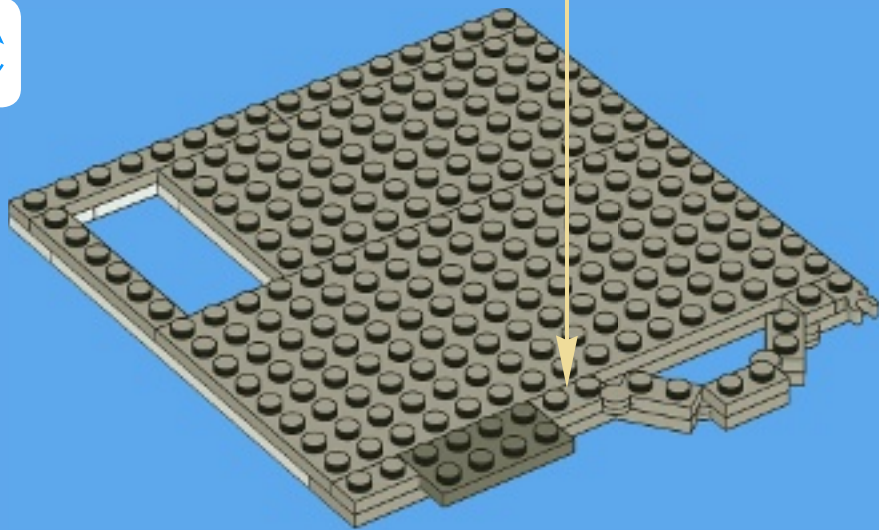
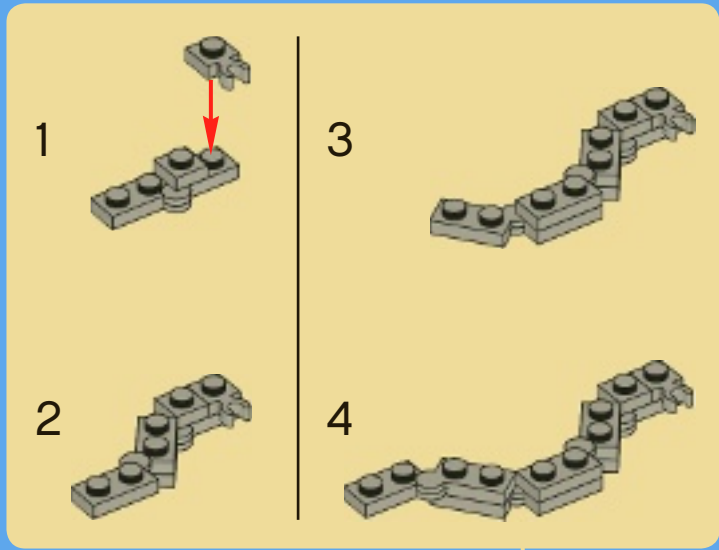

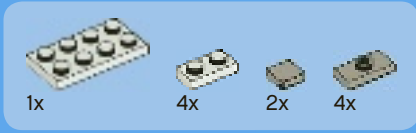

7



8

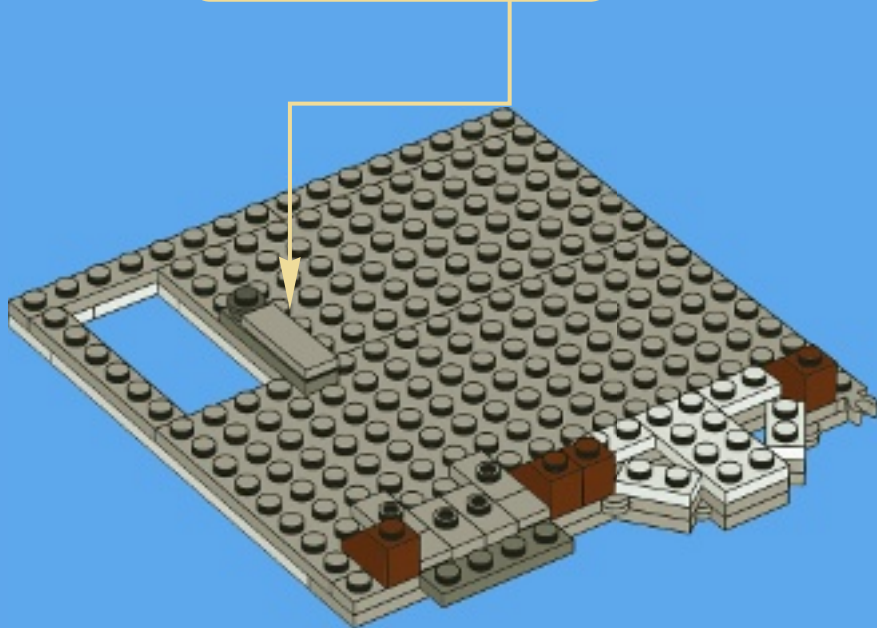
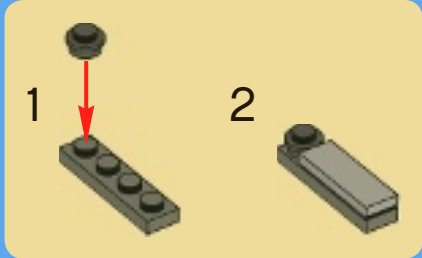

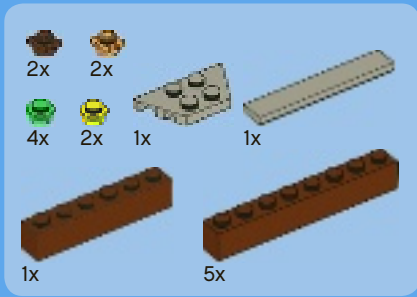

9



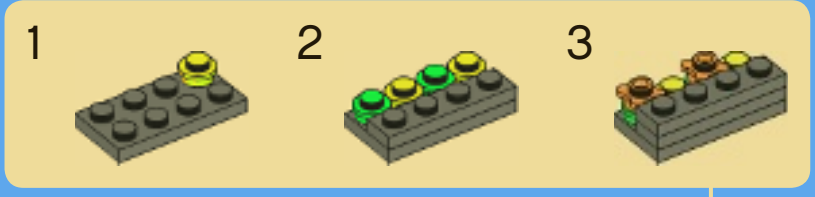
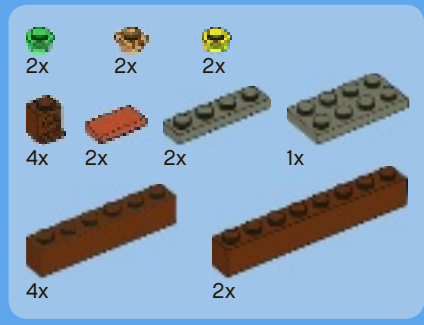

# 10

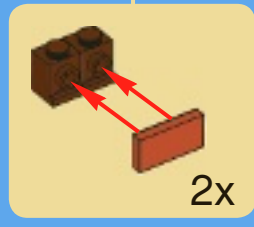
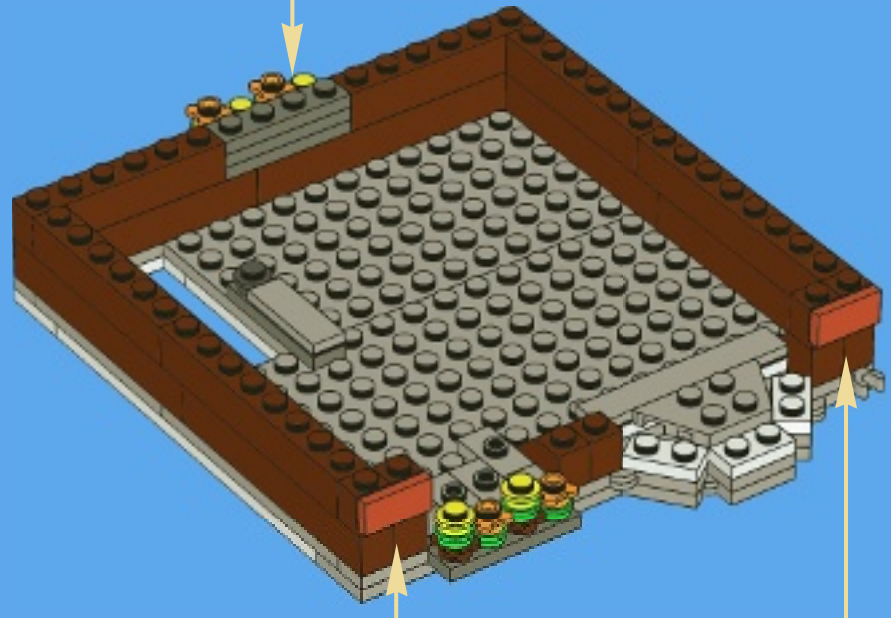



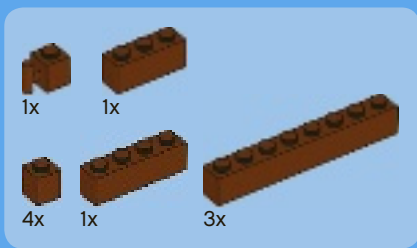

11



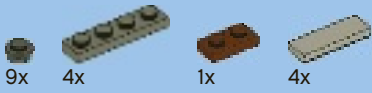

# 12

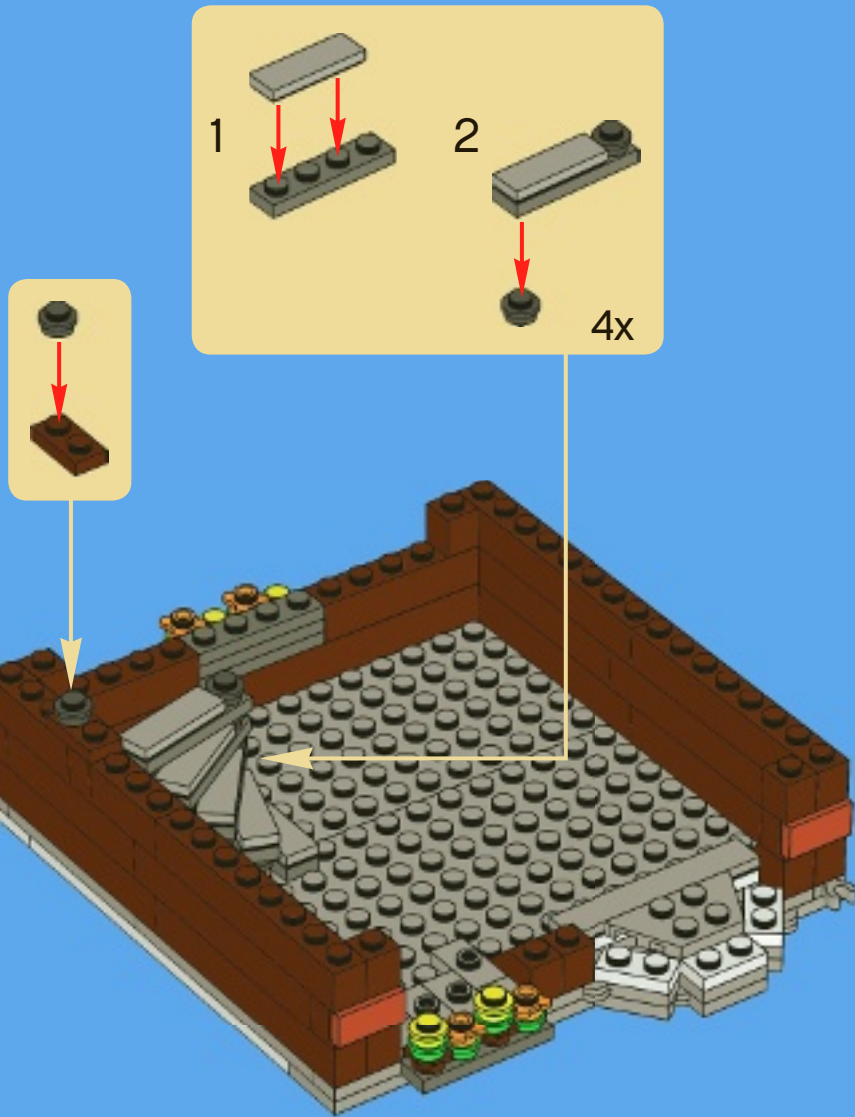

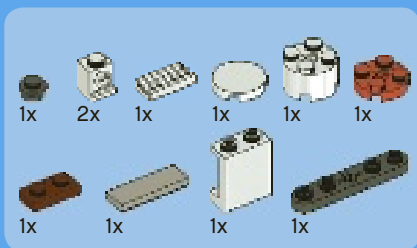

# 13

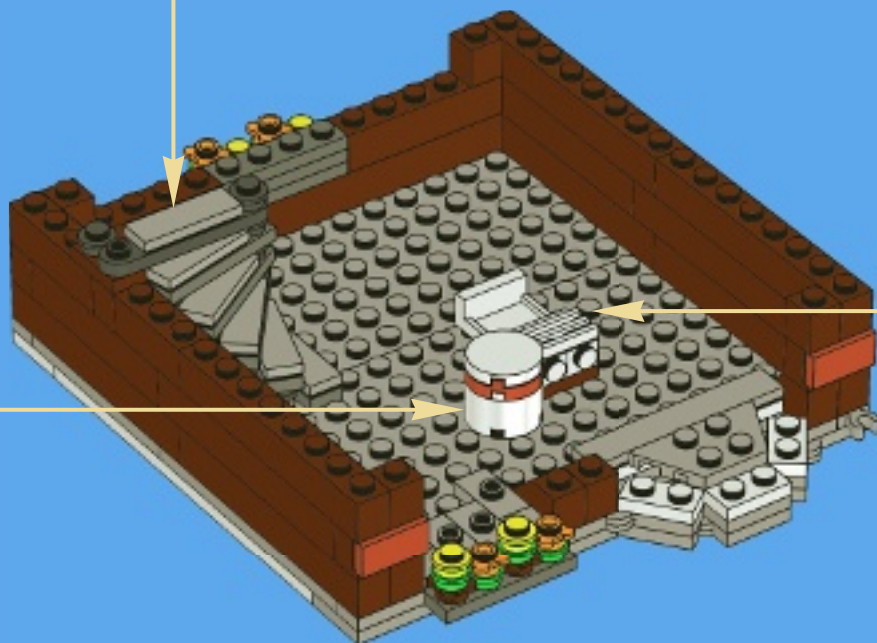
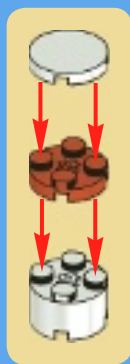
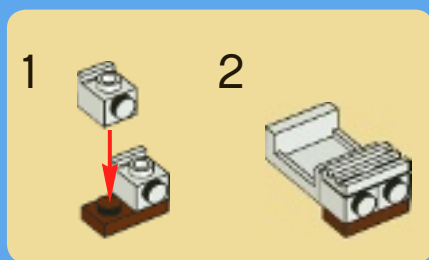
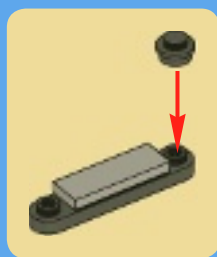

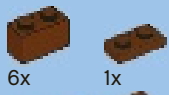

6x

1x



1x



2x

# 14



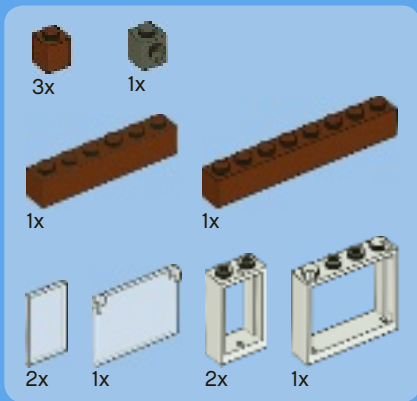

15

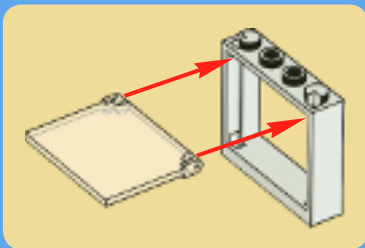
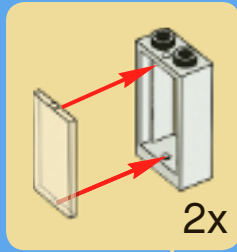

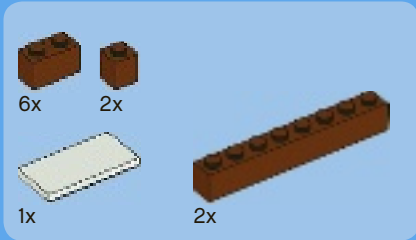

16

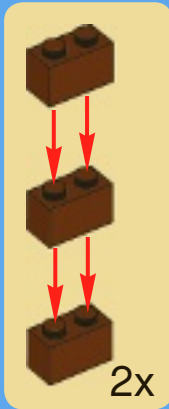

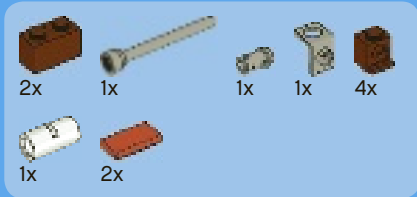

# 17

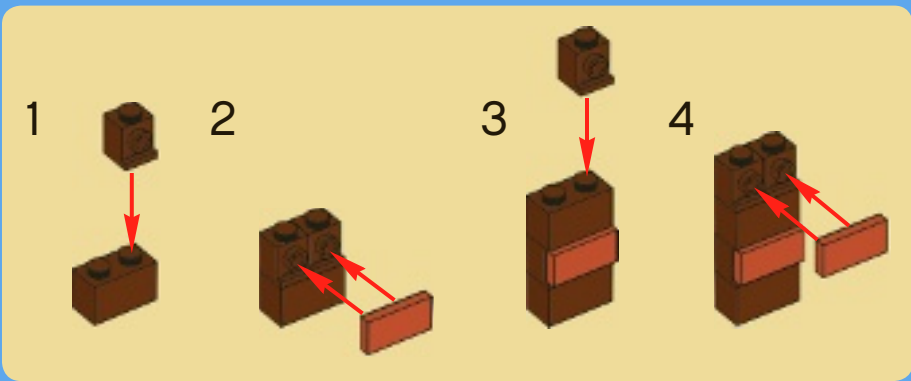
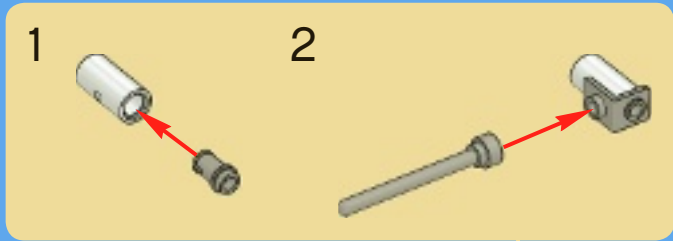

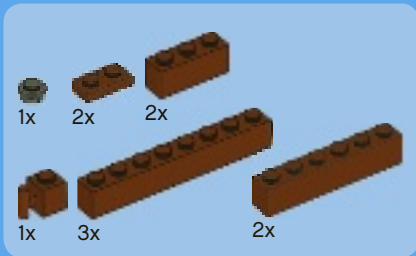

# 18

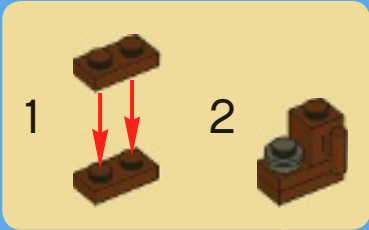





19

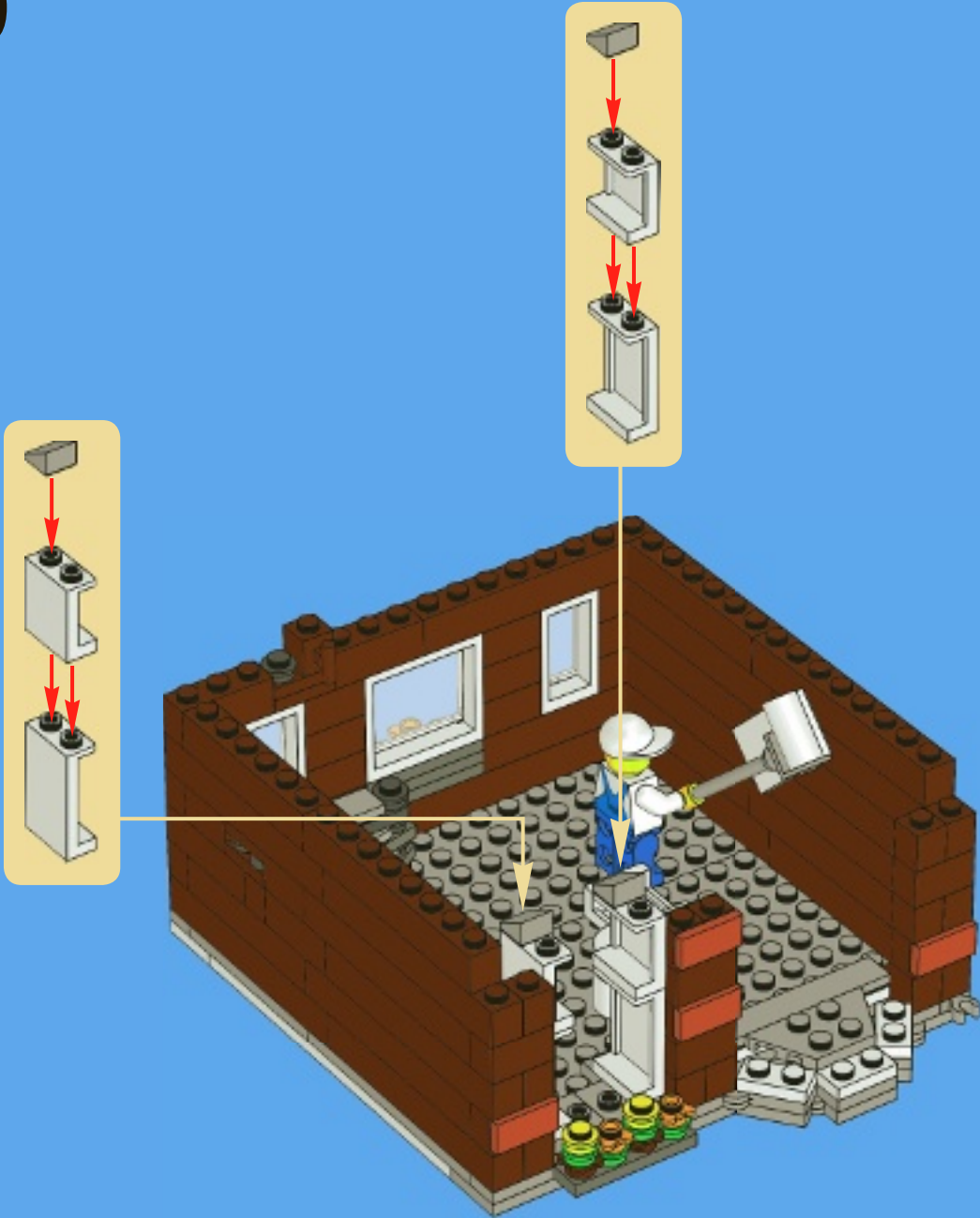



1x



7x



7x

# 20

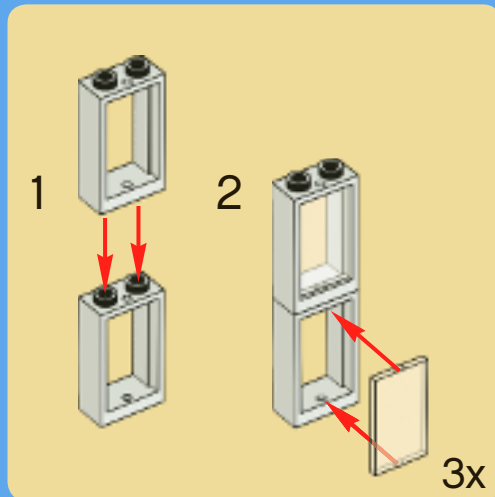
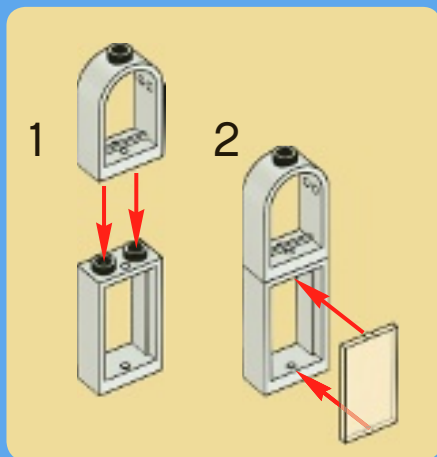



# 21

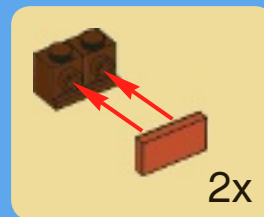
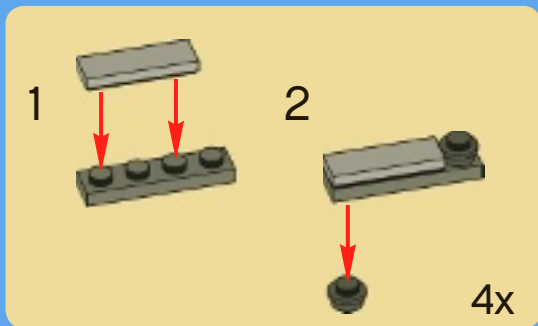

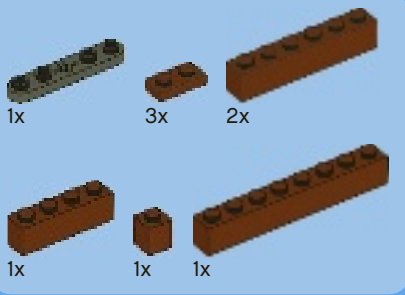

22



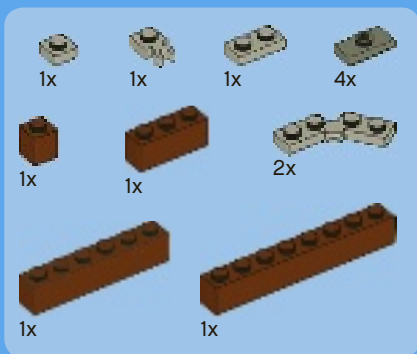

# 23





1x



2x

# 24



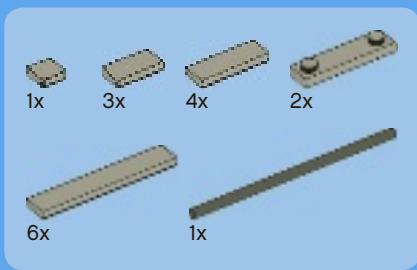

25



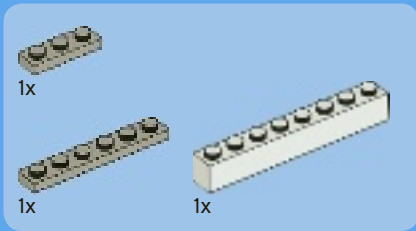

1

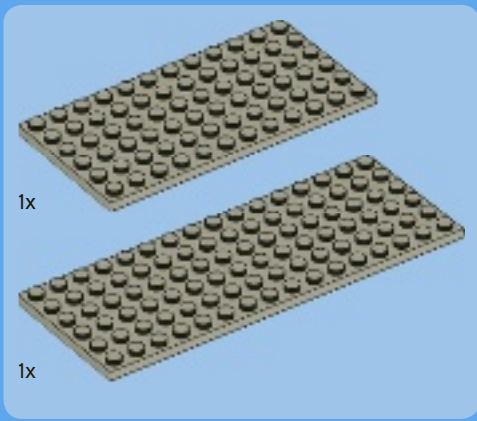
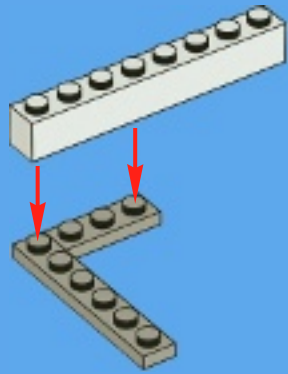

2

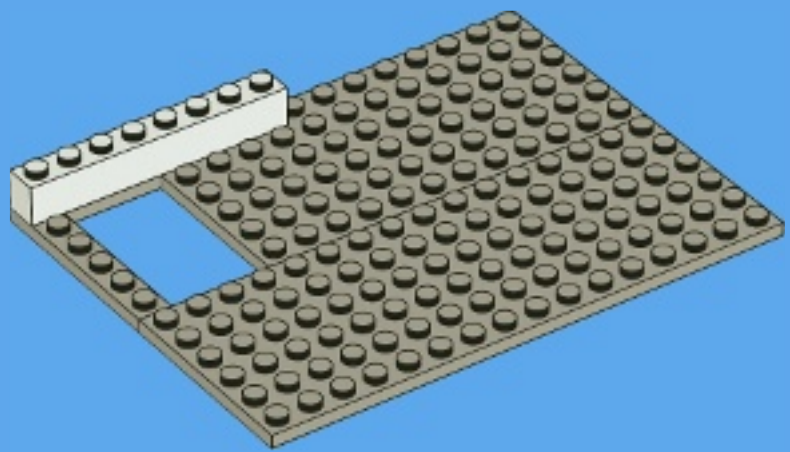



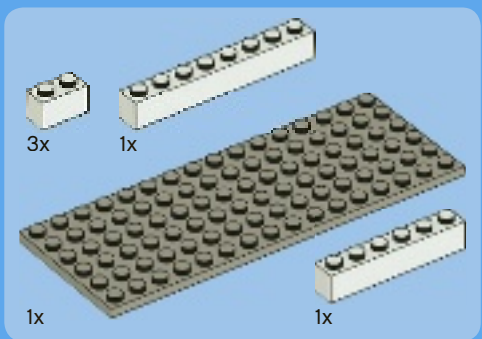

3

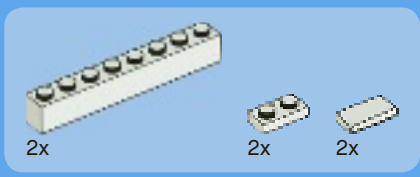
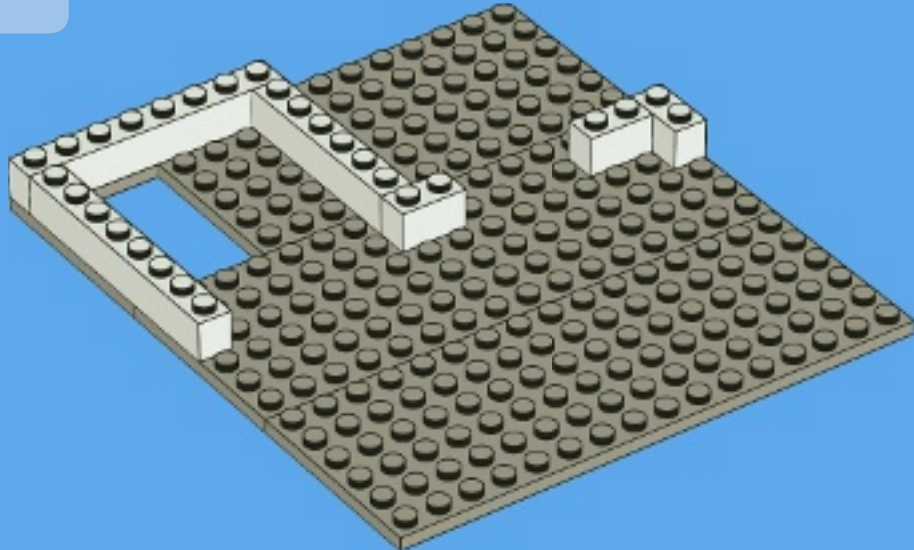

4

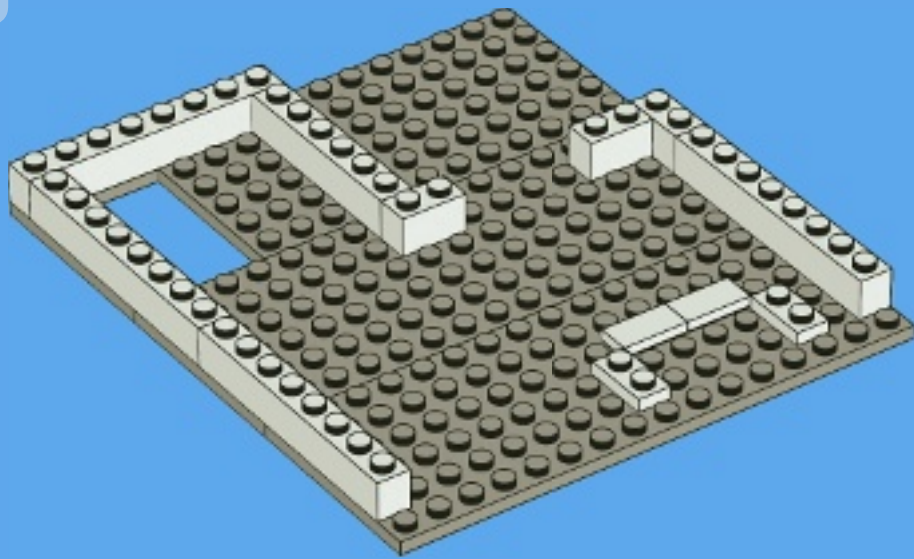

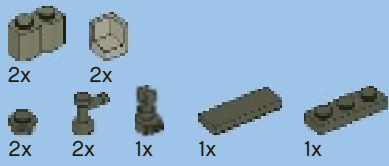

5

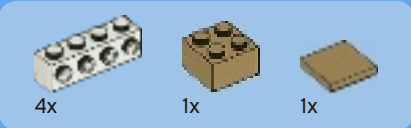
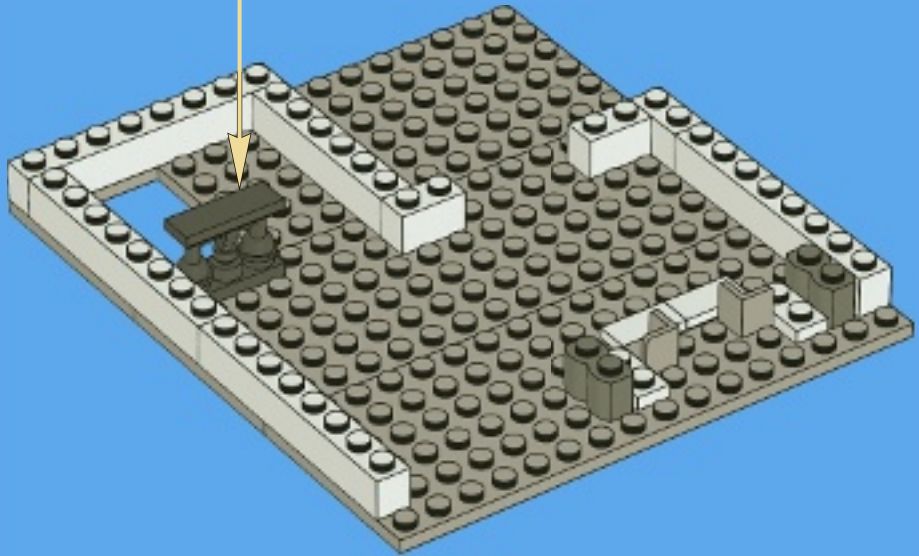

6

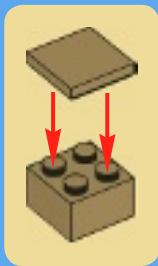

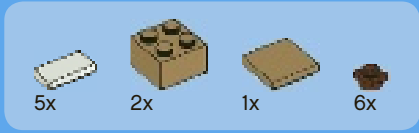

7

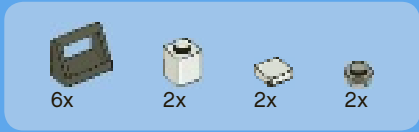
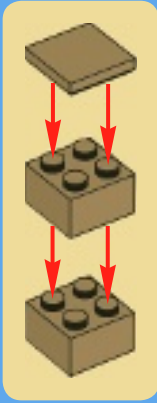

8

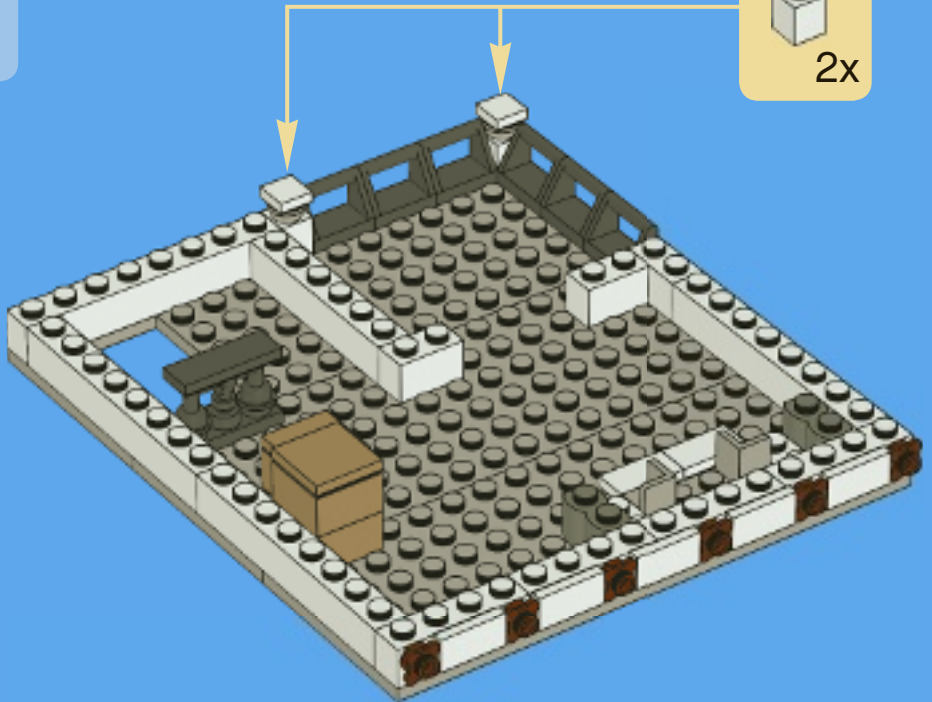
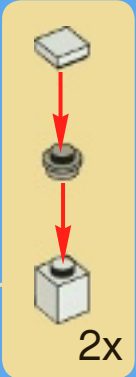

2x 2x 2x 2x 2x

1x 1x 2x 6x

# 9

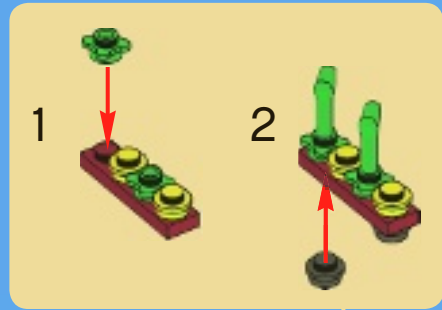

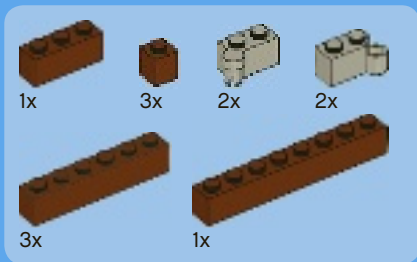

10

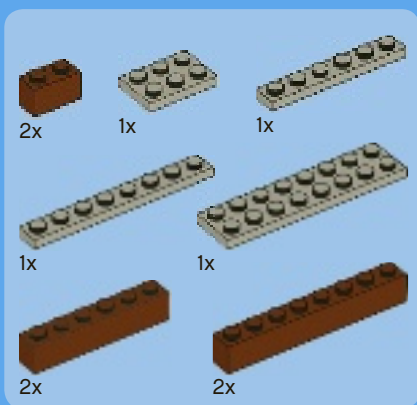
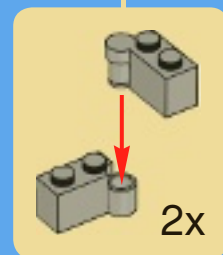

11





12



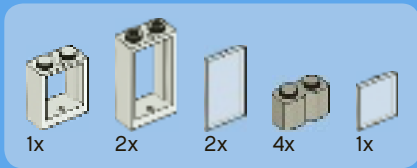

# 13

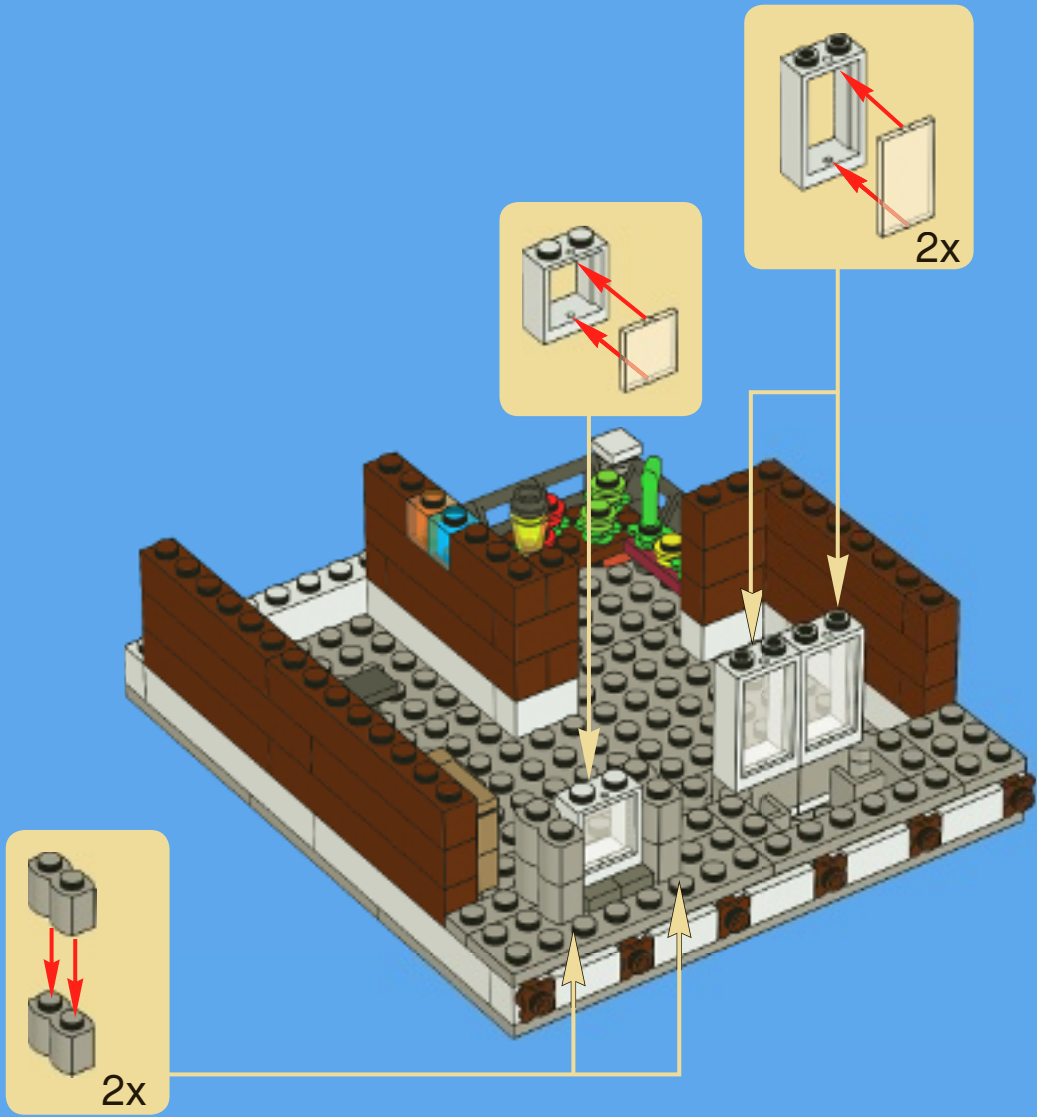

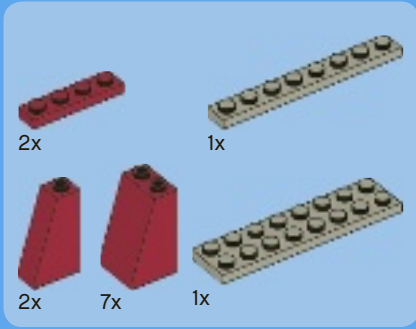

# 14

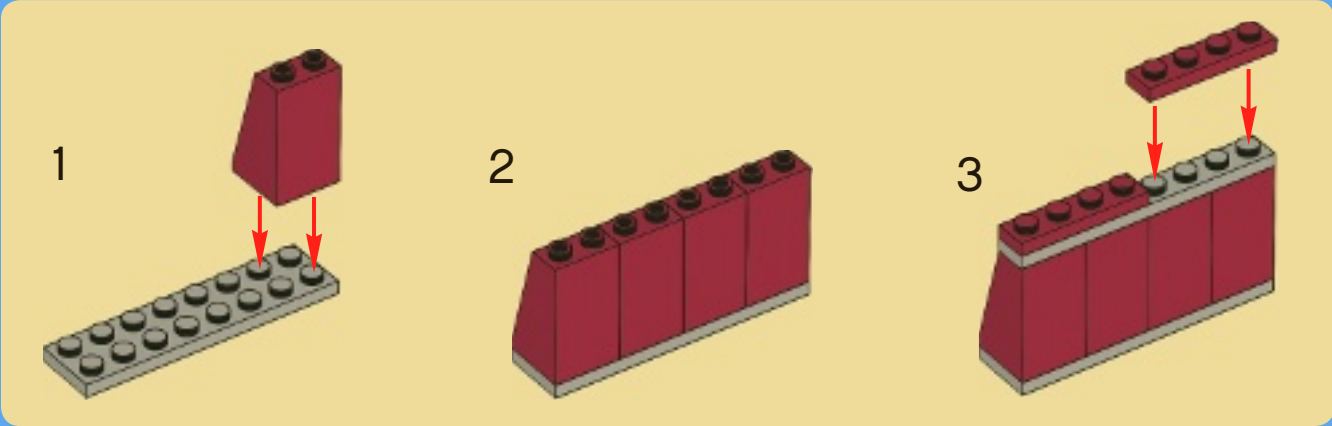





15

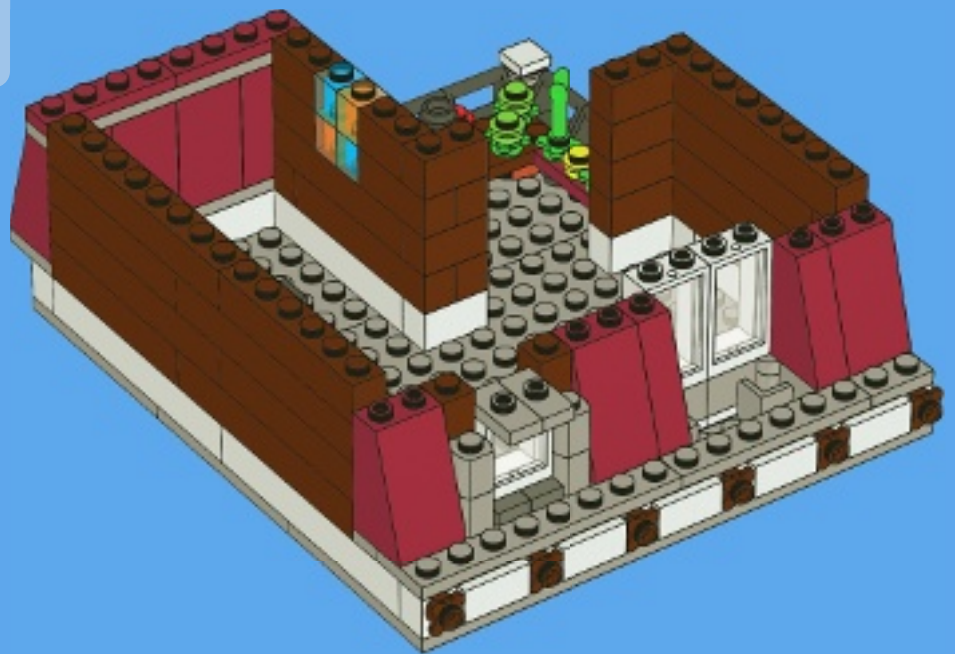

16





17

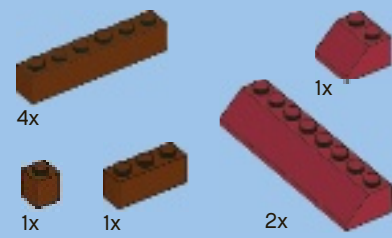
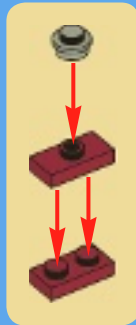

18



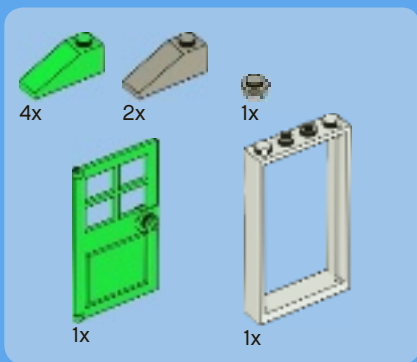

19

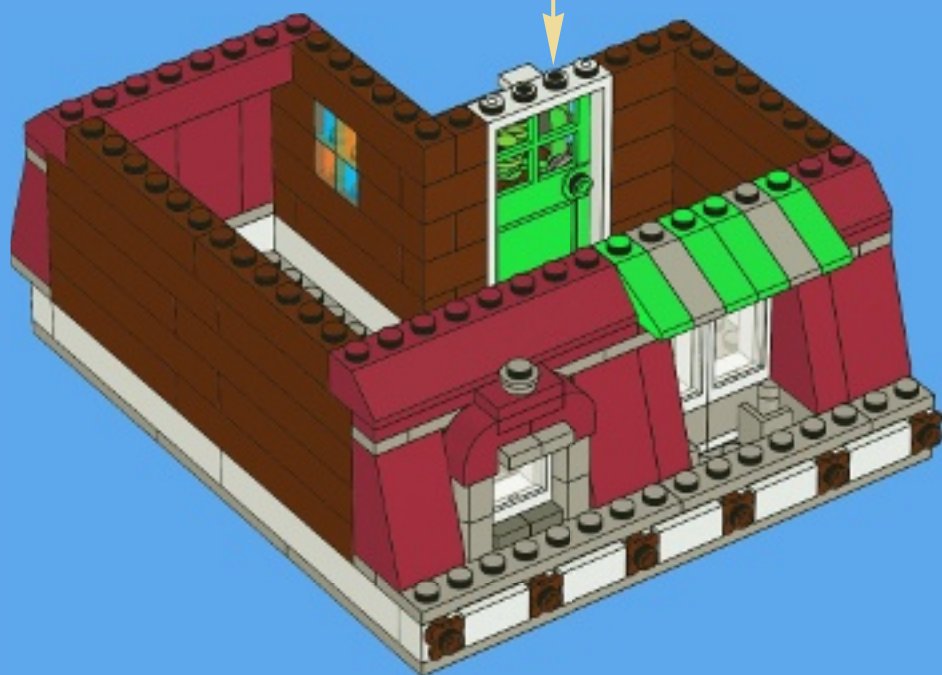
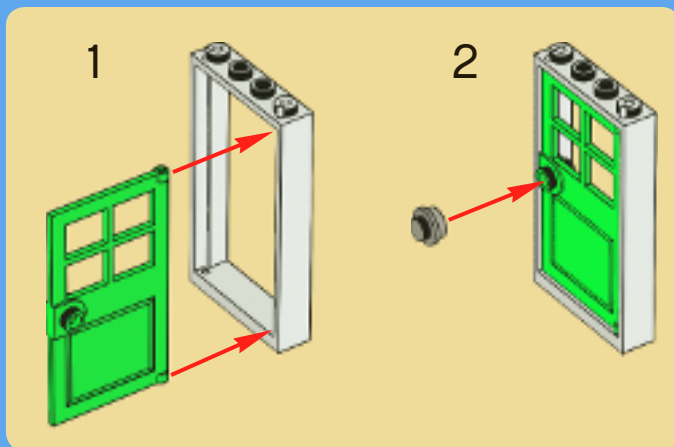



6x



2x



2x



5x

# 20

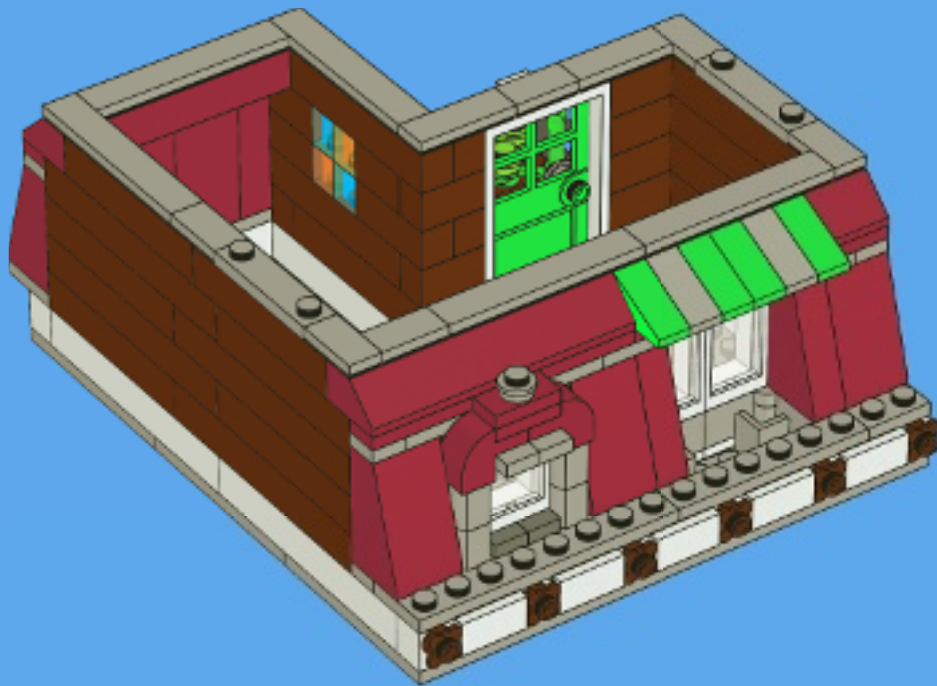

21



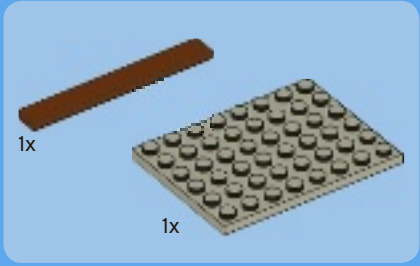
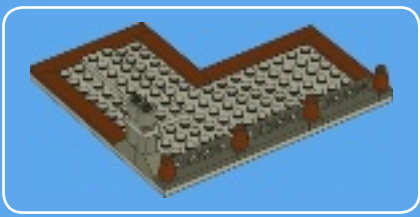

1

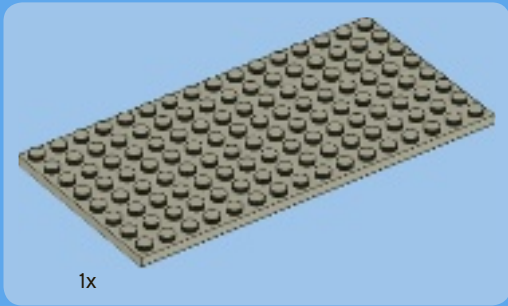
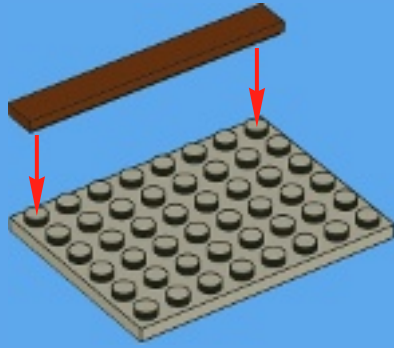

2

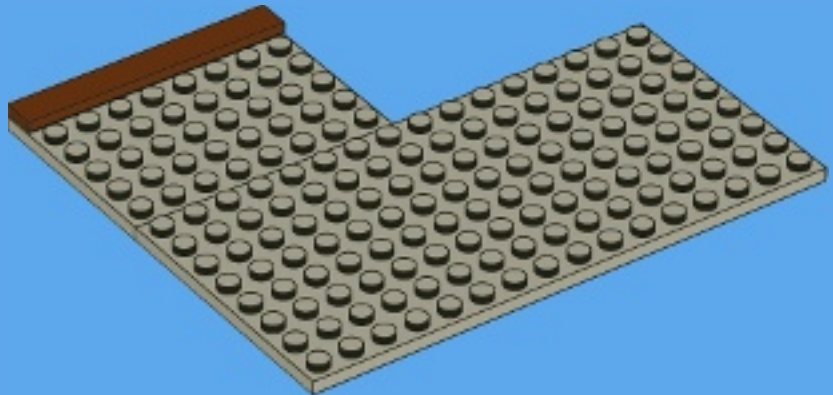

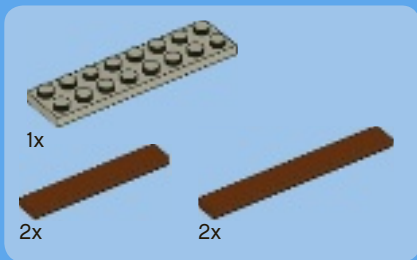

3

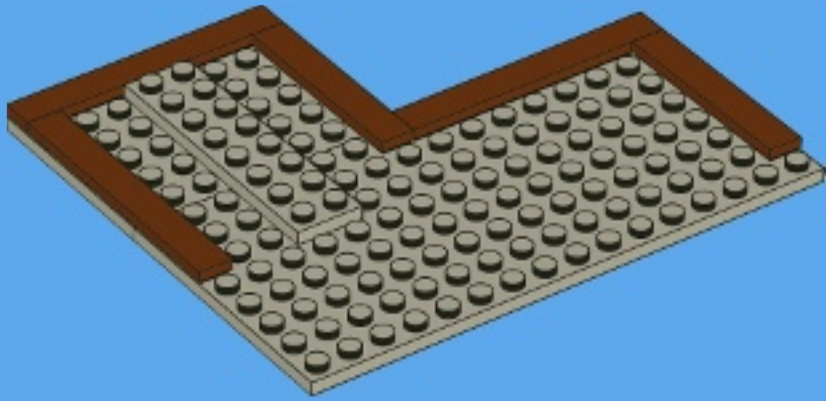

4

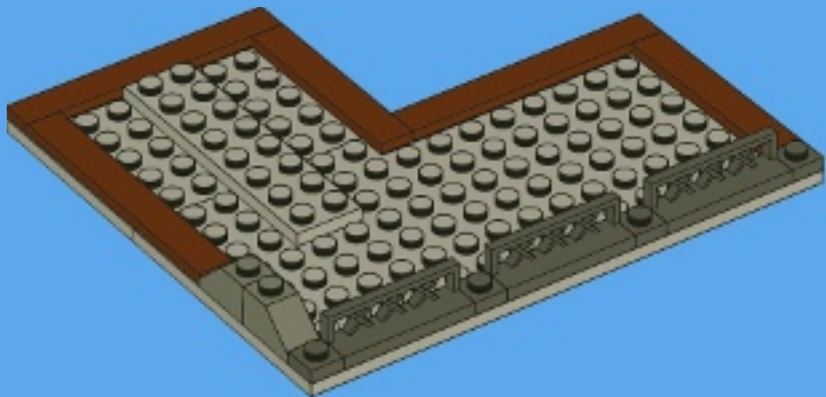

2x

1x

1x

4x

5

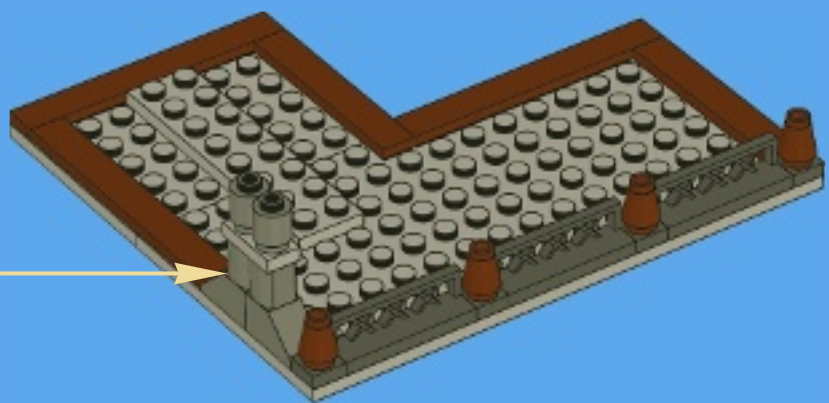
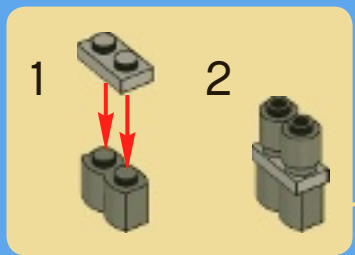

22

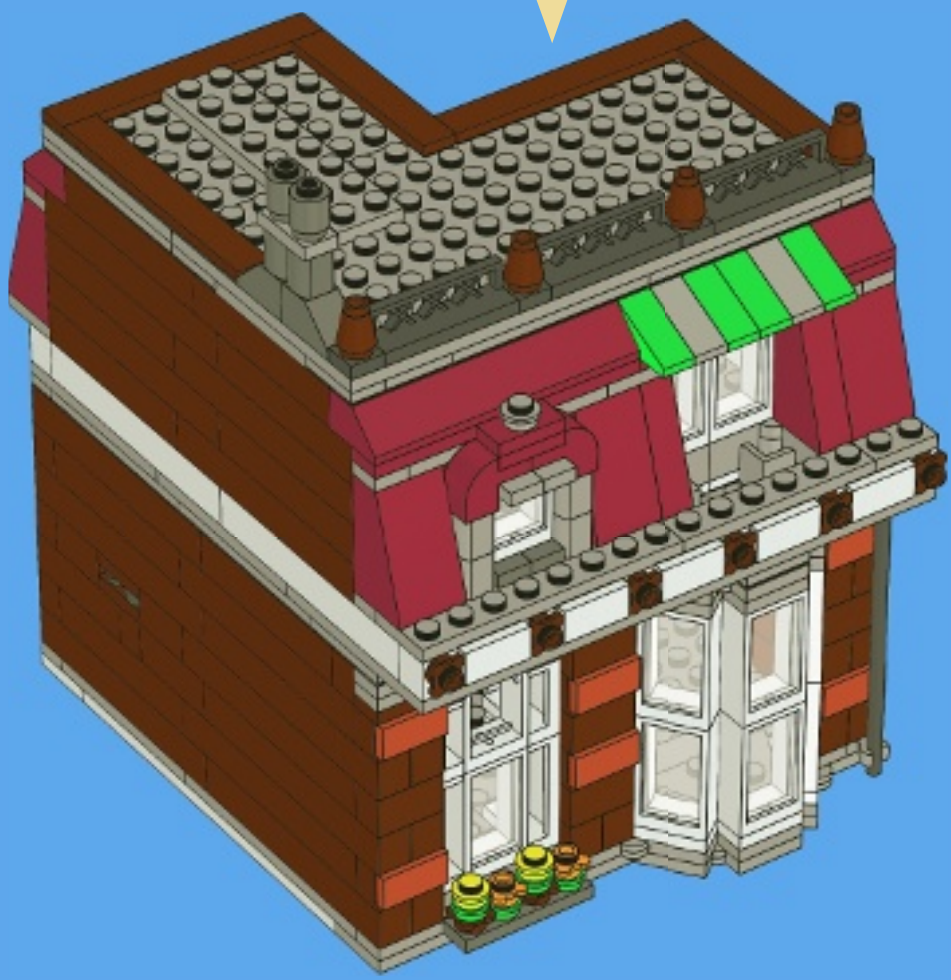



23



10197

10218

10211



10214



10219

