



# Architecture

21046

## Empire State Building

New York, USA



Booklet available in English on  
Heft in deutscher Sprache erhältlich auf  
Livret disponible en français sur  
Libretto disponibile in italiano su  
Folleto disponible en español en  
Folheto disponível em português em  
A füzet magyarul ezen a honlapon olvasható:  
Buklets latviešu valodā pieejams vietnē  
如需中文版手册, 请访问

[LEGO.com/architecture](http://LEGO.com/architecture)



# An Icon of its Time

At 102 stories, the Empire State Building may no longer be the tallest skyscraper in New York, but it is undoubtedly one of the most significant. No visit to the city is complete without a trip to the building's observation deck to experience the unforgettable views of the city. Designed by Shreve, Lamb & Harmon and completed in 1931, a lot of the building's cultural significance lies within its great history. A sign of hope and optimism during the Great Depression, it was built in record time and became the tallest building in the world, a title it retained for almost 40 years.

The Empire State Building also embodies the refinement and evolution of steel construction and technological prowess, though its design and construction faced many technical problems at the time. But a spirit of innovation and determination prevailed, and the building has taken its place in architectural and cultural history as a symbol of power and grandeur.





# The Creation of an Icon

Originally agricultural land, the prominent Astor family bought the area in 1827 and built the Waldorf-Astoria hotel on the site in the late 1890s. Eventually, businessman John Raskob and former governor Al Smith, who later became part of the Empire State Inc. group of investors, bought and demolished the outdated hotel, and contracted William Lamb to create the building design.

Before the designs were even finished, work started on the building's construction on March 17th, 1930. The pace of construction was phenomenal; with an average construction rate of four and a half stories a week. By September of the same year, 86 stories were built, and the mast was completed by November. The entire construction was finished, and the building officially opened by President Hoover on May 1st, 1931, 45 days ahead of schedule.

# A Symbol of New York

After its construction, the Empire State Building became an instant tourist attraction, with visitors coming to see the spectacular views from the observation deck of the “World’s Tallest Building.” It became a National Historic Landmark in 1986 and was added to the National Register of Historic Places the year after. The American Society of Civil Engineers has also named it as one of the Seven Wonders of the Modern World, and in 2007 it was ranked at number one on the list of America’s Favorite Architecture by the American Institute of Architects. Aside from its many accolades and titles, the Empire State Building is a cultural symbol of New York, with starring roles in many movies, from the original King Kong to Sleepless in Seattle.



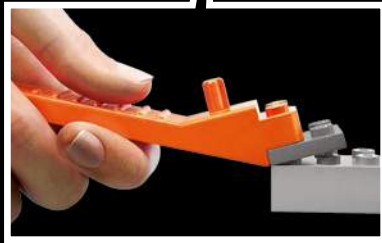
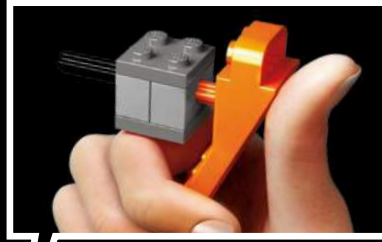
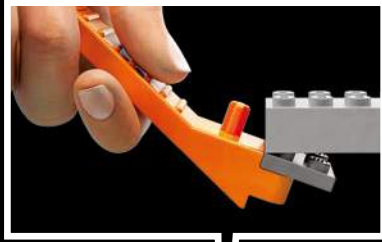

[LEGO.com/brickseparator](https://LEGO.com/brickseparator)



- 1** Download the LEGO® Life App  
 Lade dir die LEGO® Life App herunter  
 Télécharge l'application LEGO® Life  
 Télécharger l'application LEGO® Life  
 Scarica l'app LEGO® Life  
 Descarga la app LEGO® Life  
 Descarrega a App LEGO® Life  
 Töltsd le a LEGO® Life Appot!  
 Lejupielādē lietotni LEGO® Life  
 下載 LEGO® Life 应用程序



- 2** Scan the code on the front cover  
 Scanne den Code auf der Titelseite  
 Scanne le code sur la page de couverture  
 Scanner le code sur la page couverture  
 Scansiona il codice sulla copertina  
 Escanea el código de la portada  
 Faz scan do código na frente da capa  
 Olvasd be a borítón látható kódot!  
 Noskenē kodu uz priekšējā vāka  
 扫描封面上的二维码



- 3** Get the Building Instructions  
 Hol dir die Bauanleitung  
 Obtens les instructions de montage  
 Obtenir les instructions de montage  
 Scarica le istruzioni per la costruzione  
 Consulta las instrucciones de construcción  
 Obtém as Instruções de Construção  
 Szerezd be az építési útmutatókat!  
 Saņem būvēšanas instrukcijas  
 获取拼搭说明

**LEGO.com/apps**

Check for compatibility  
 Kompatibilität prüfen  
 Vérifier la compatibilité  
 Controlla la compatibilità  
 Comprueba tu compatibilidad

Verificar a compatibilidade  
 Ellenőrizd a kompatibilitást  
 Pārbaudīt saderību  
 检查兼容性

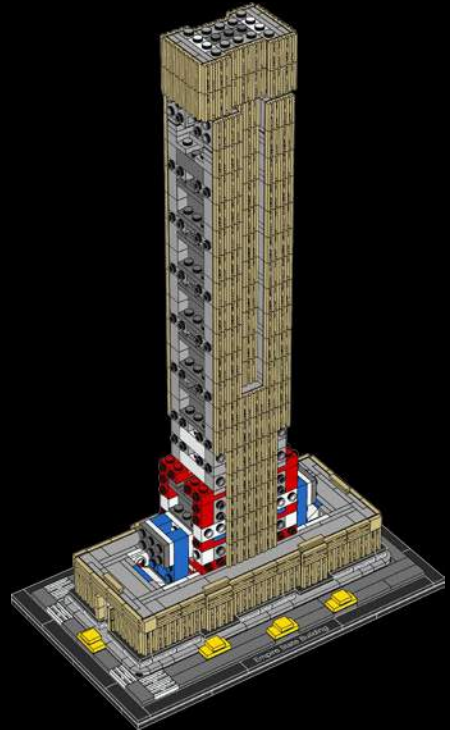
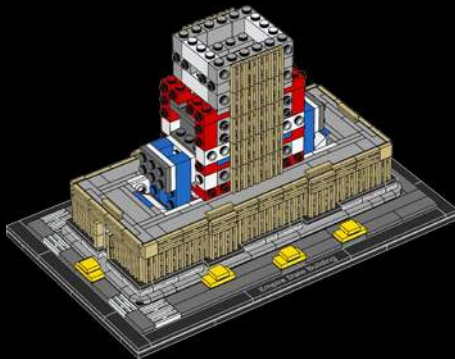
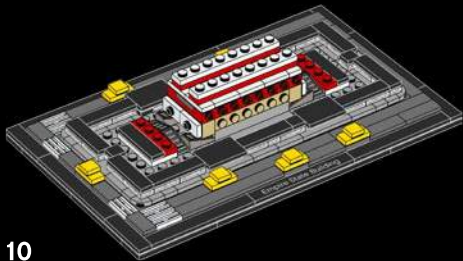

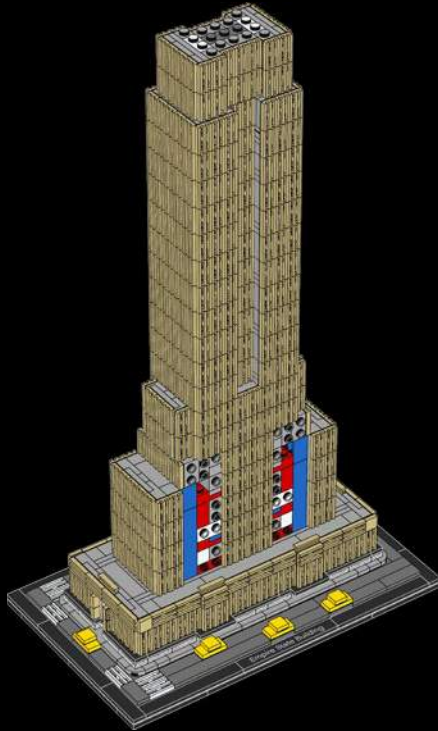

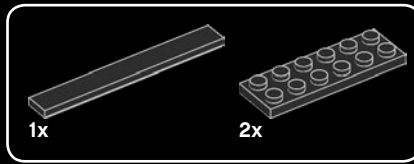

1

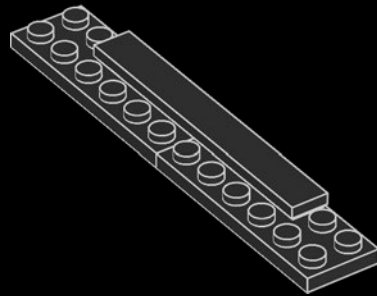
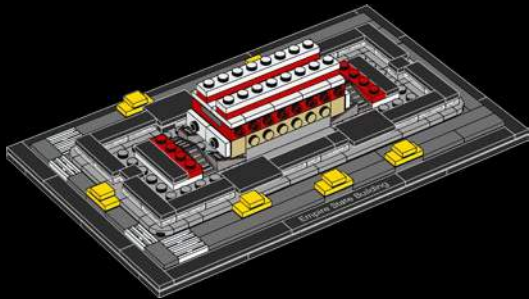

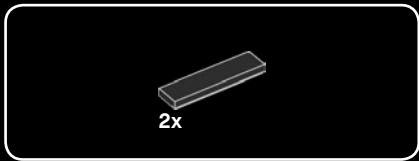

2

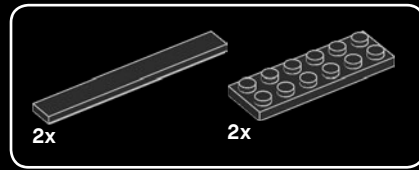
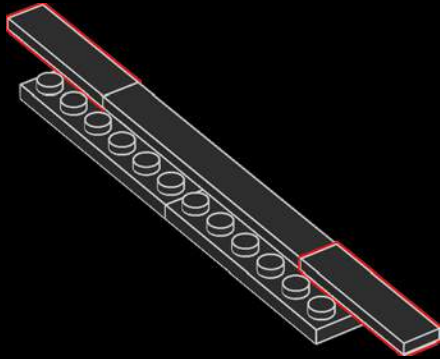

3

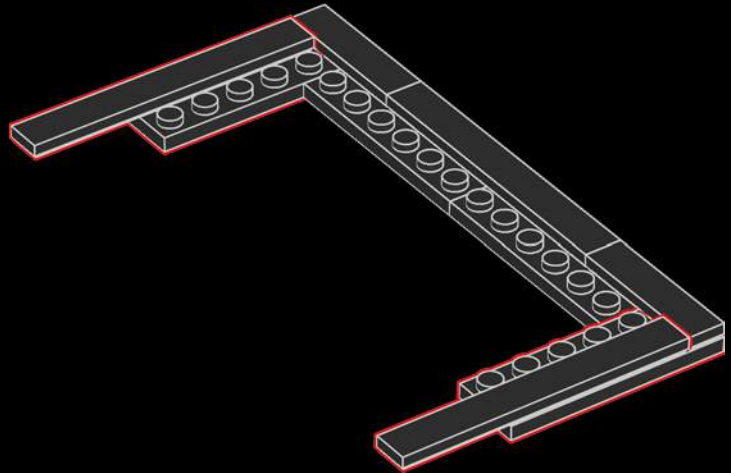

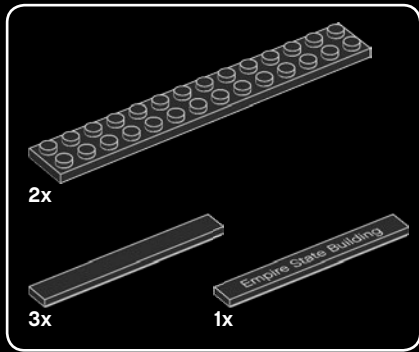

4

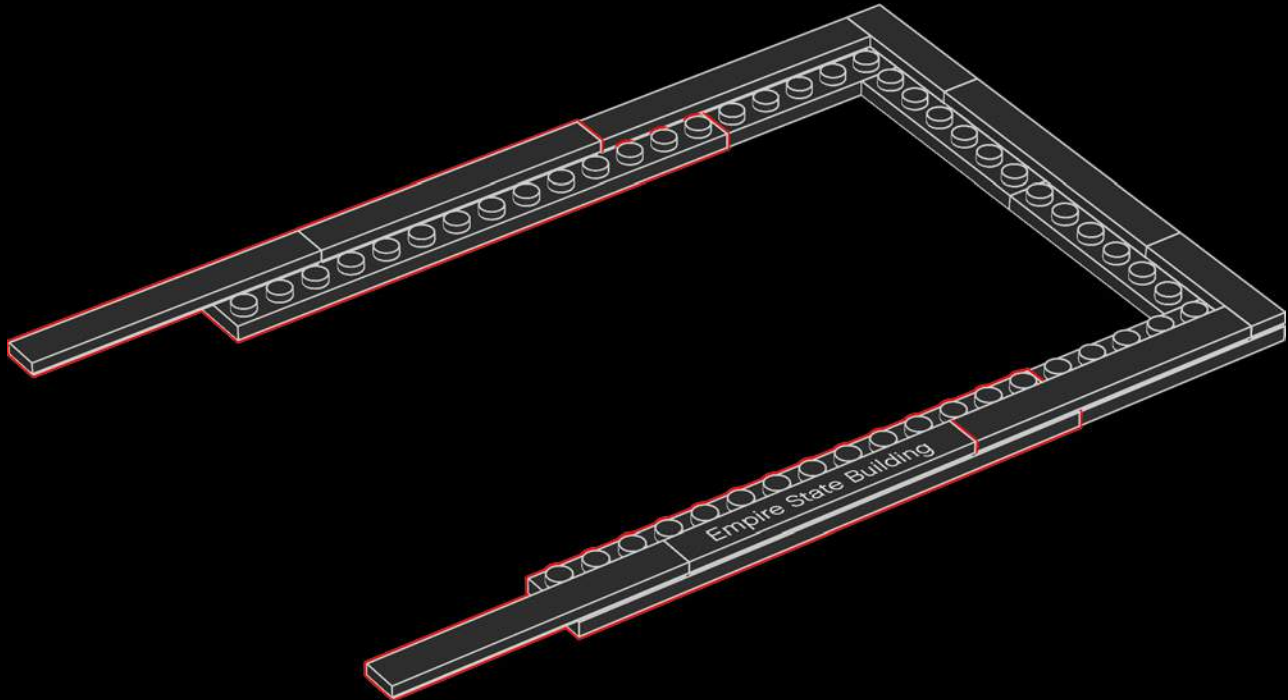

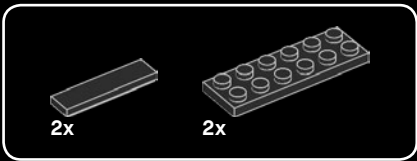

5

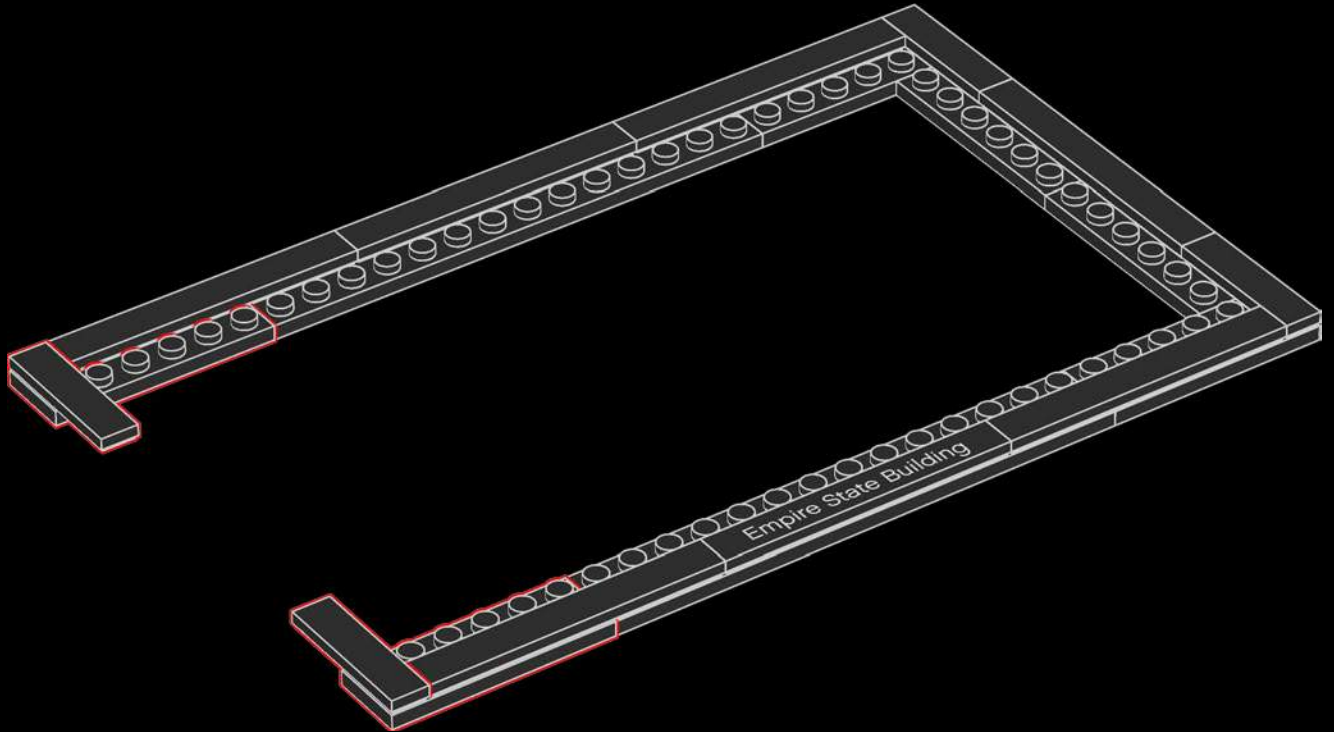

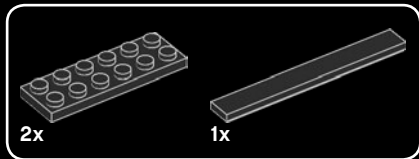

6

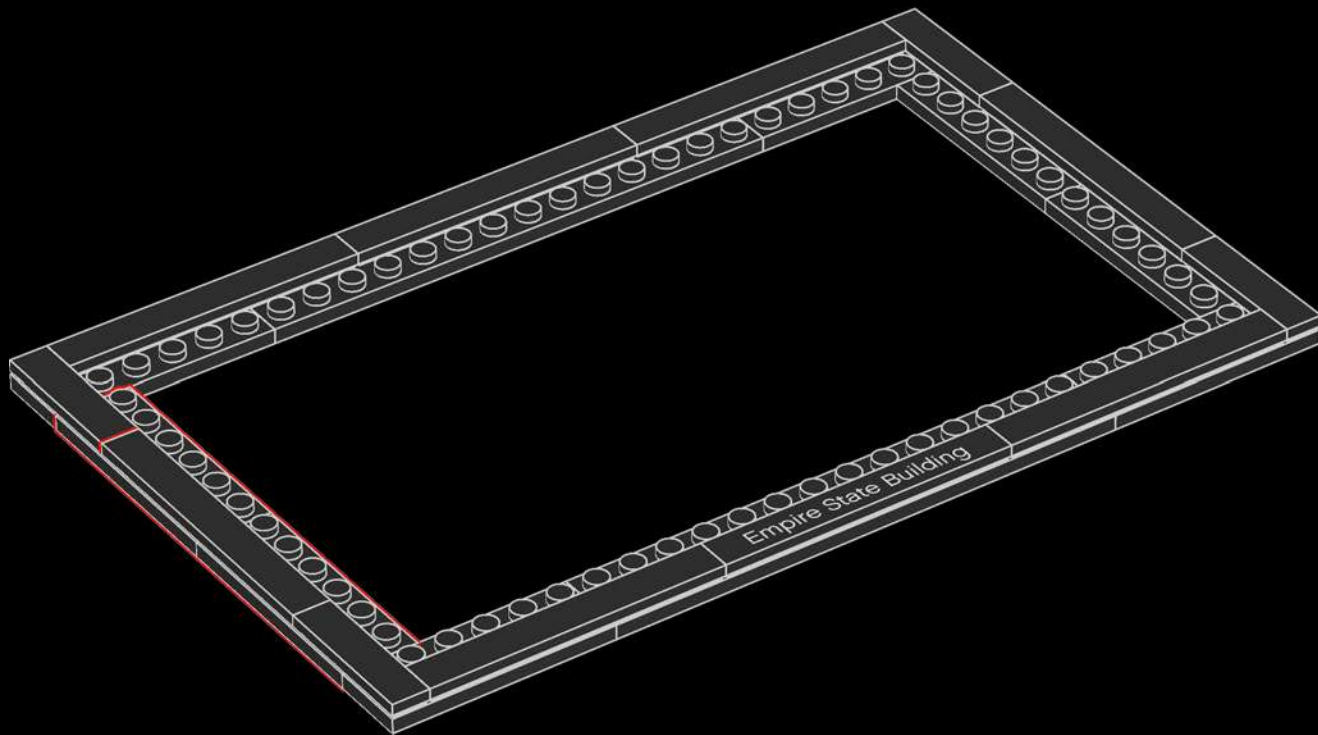

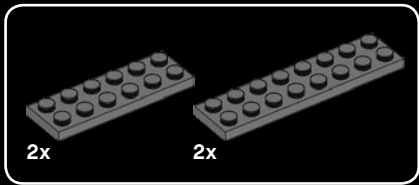

7

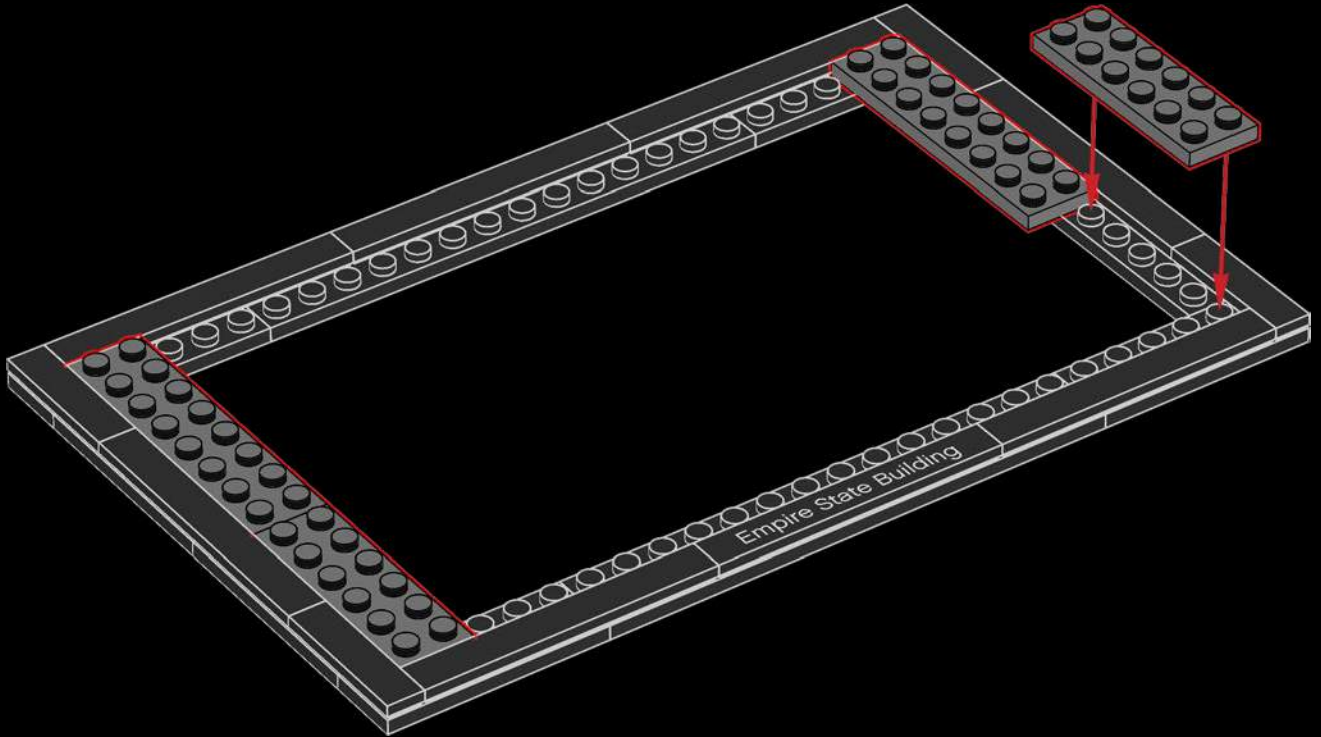

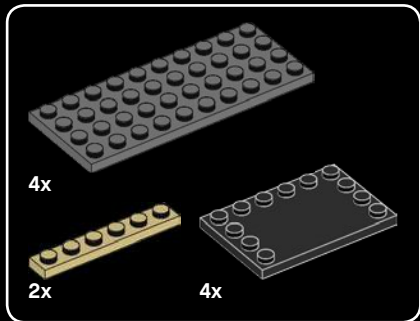
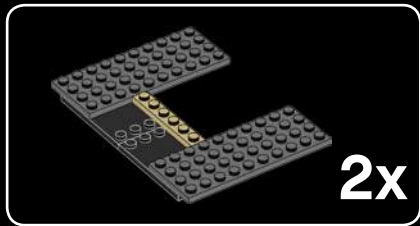

8

1

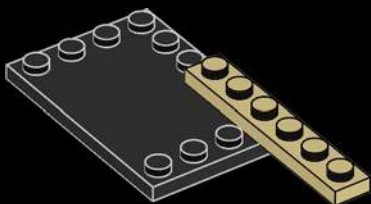

2

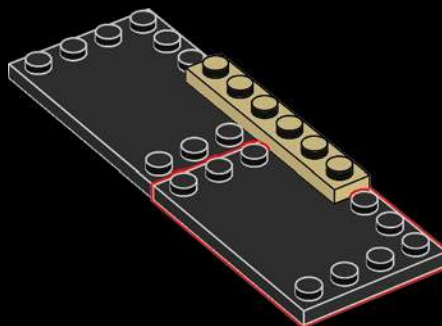

3

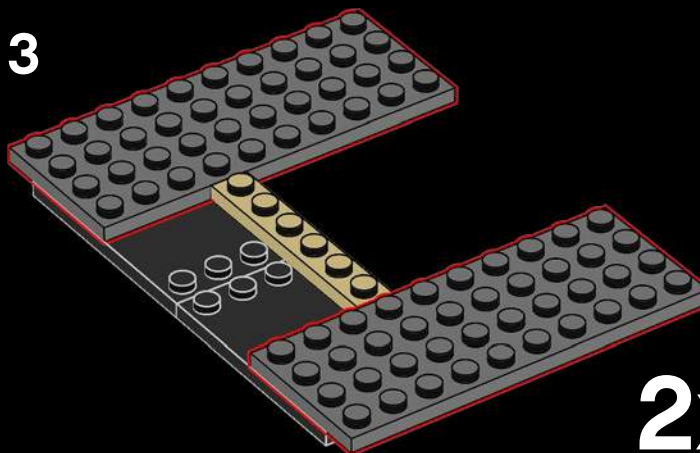

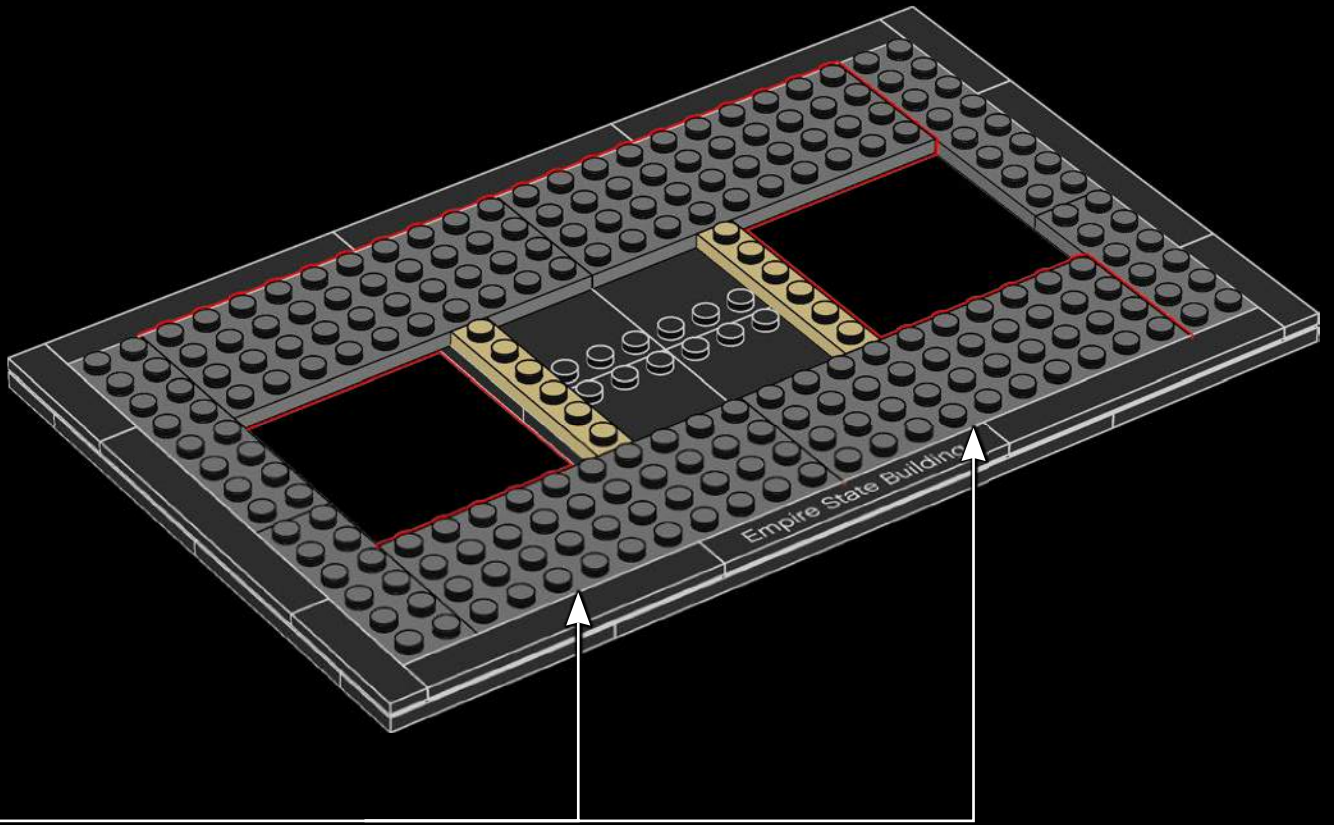



4x

9

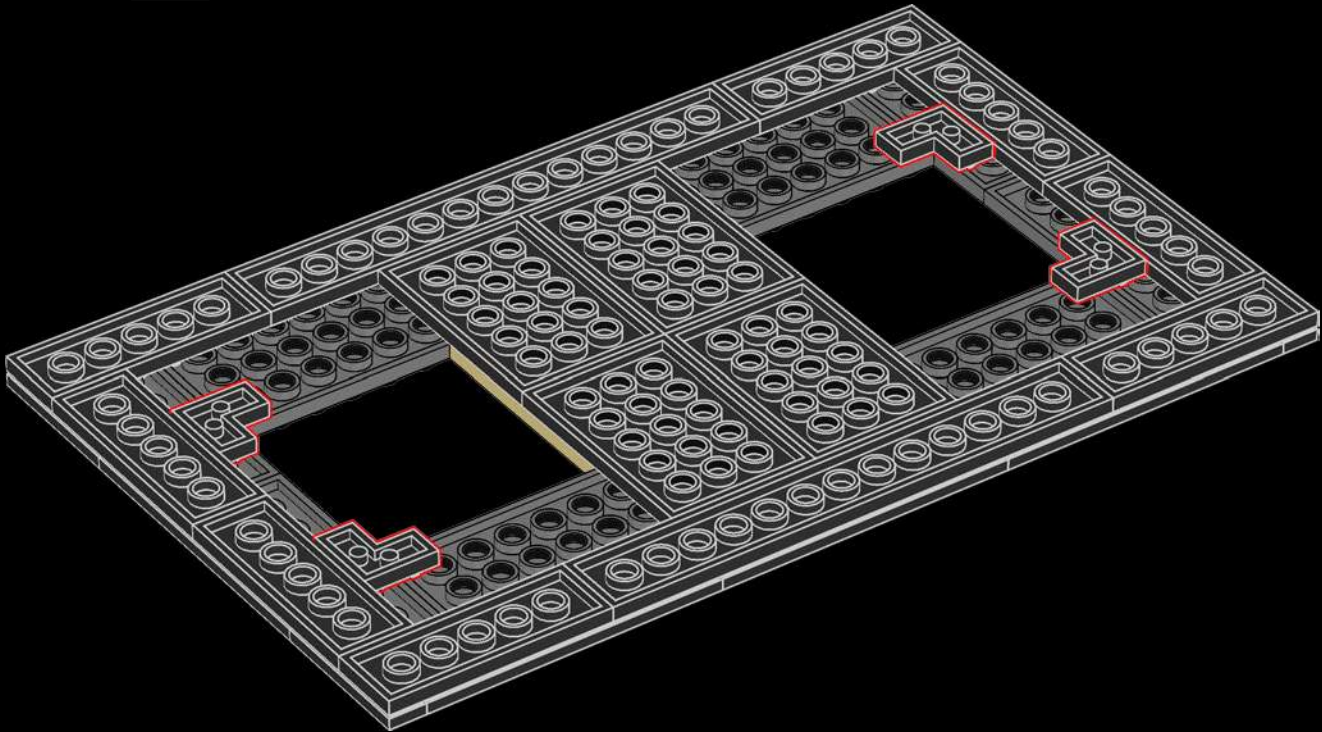

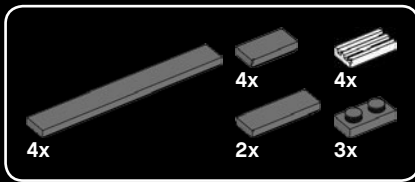

10

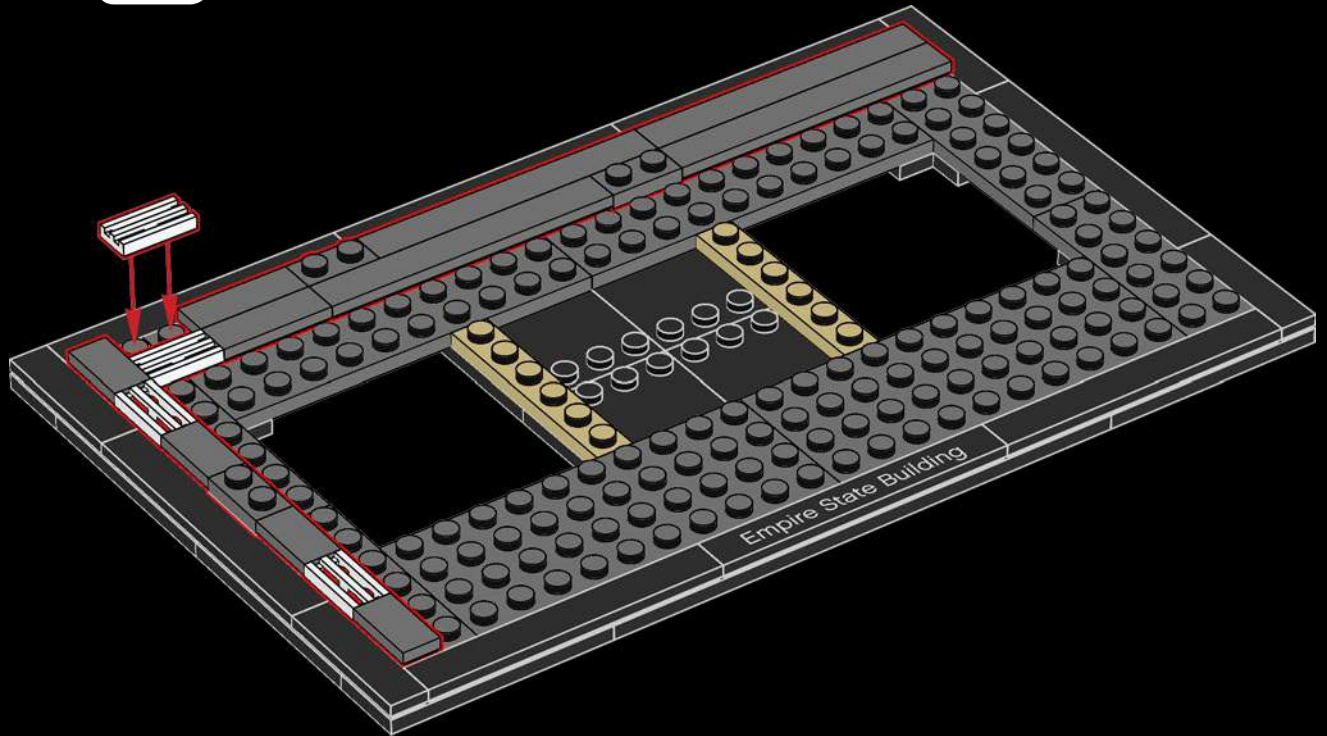

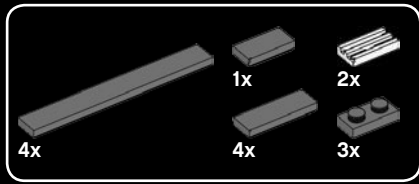

# 11

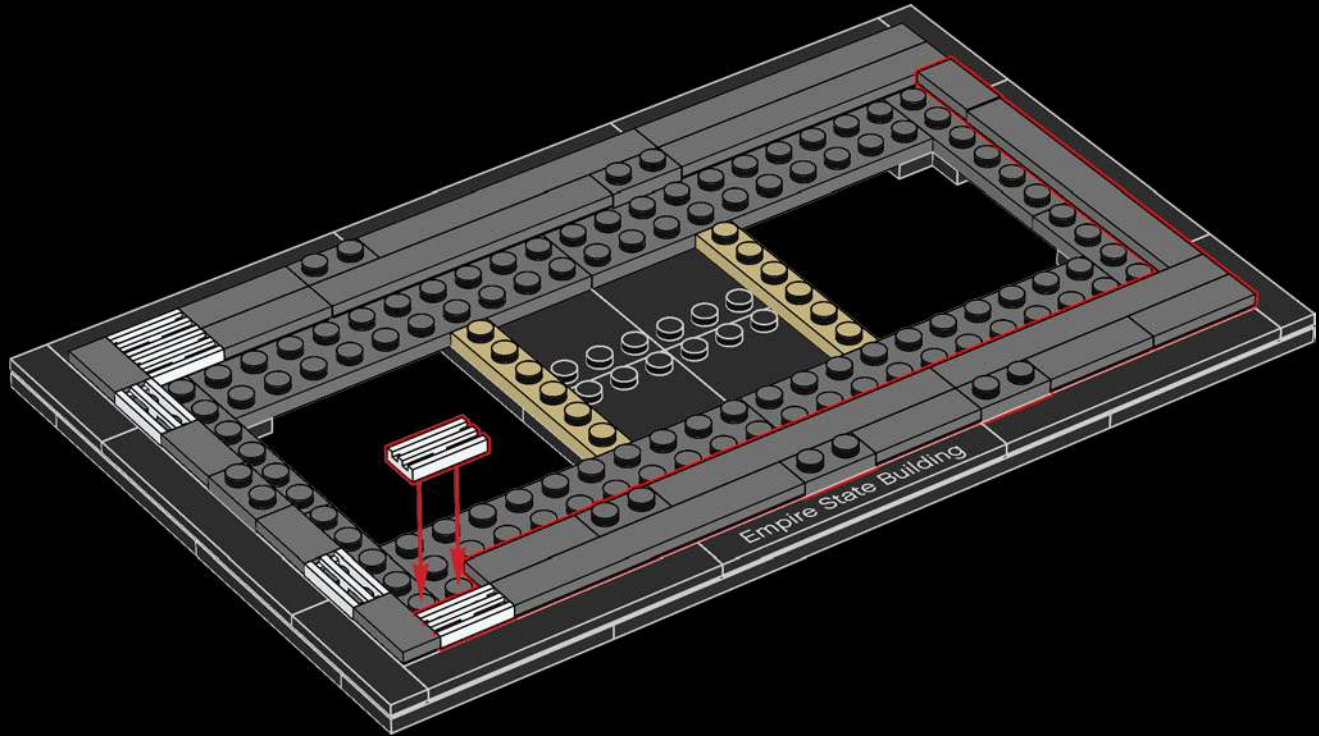

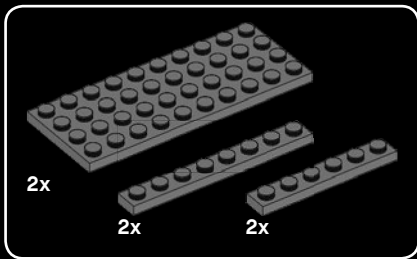

12

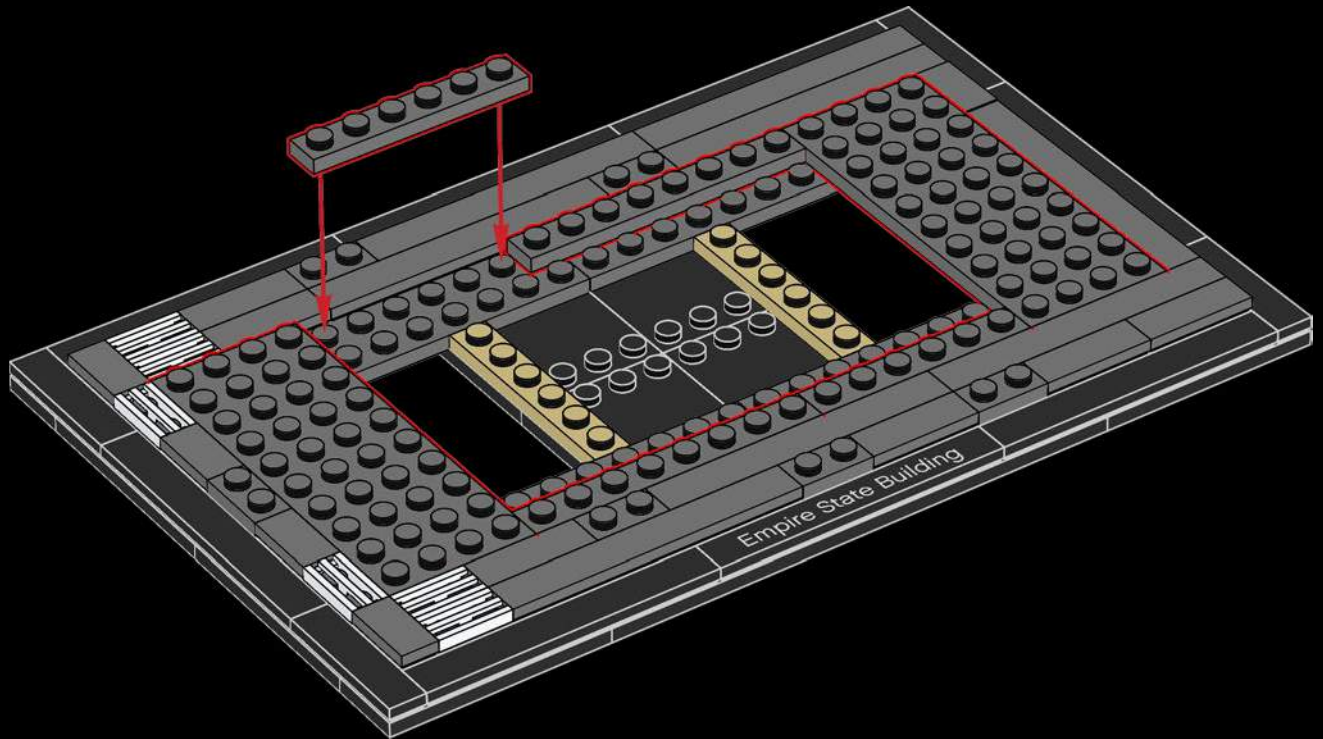

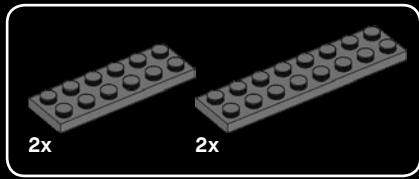

13

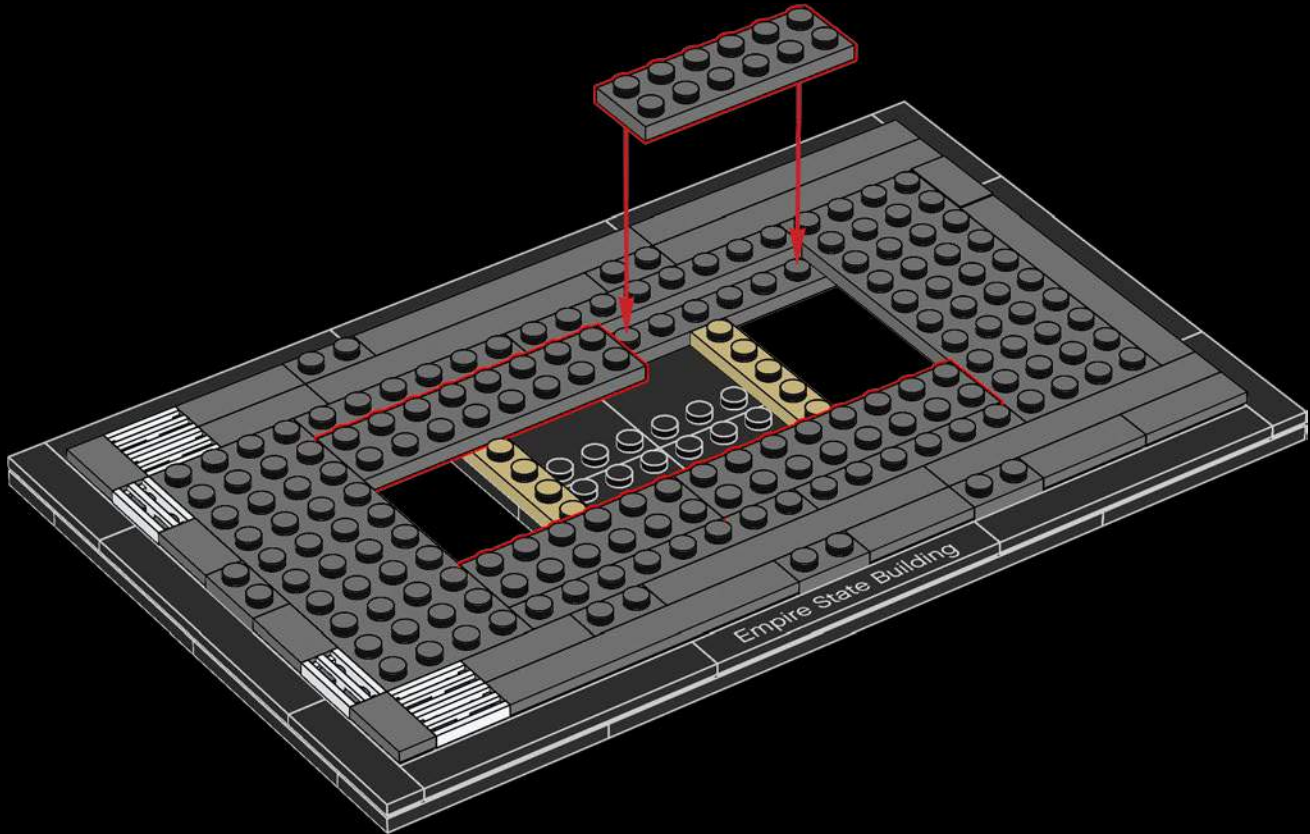



14

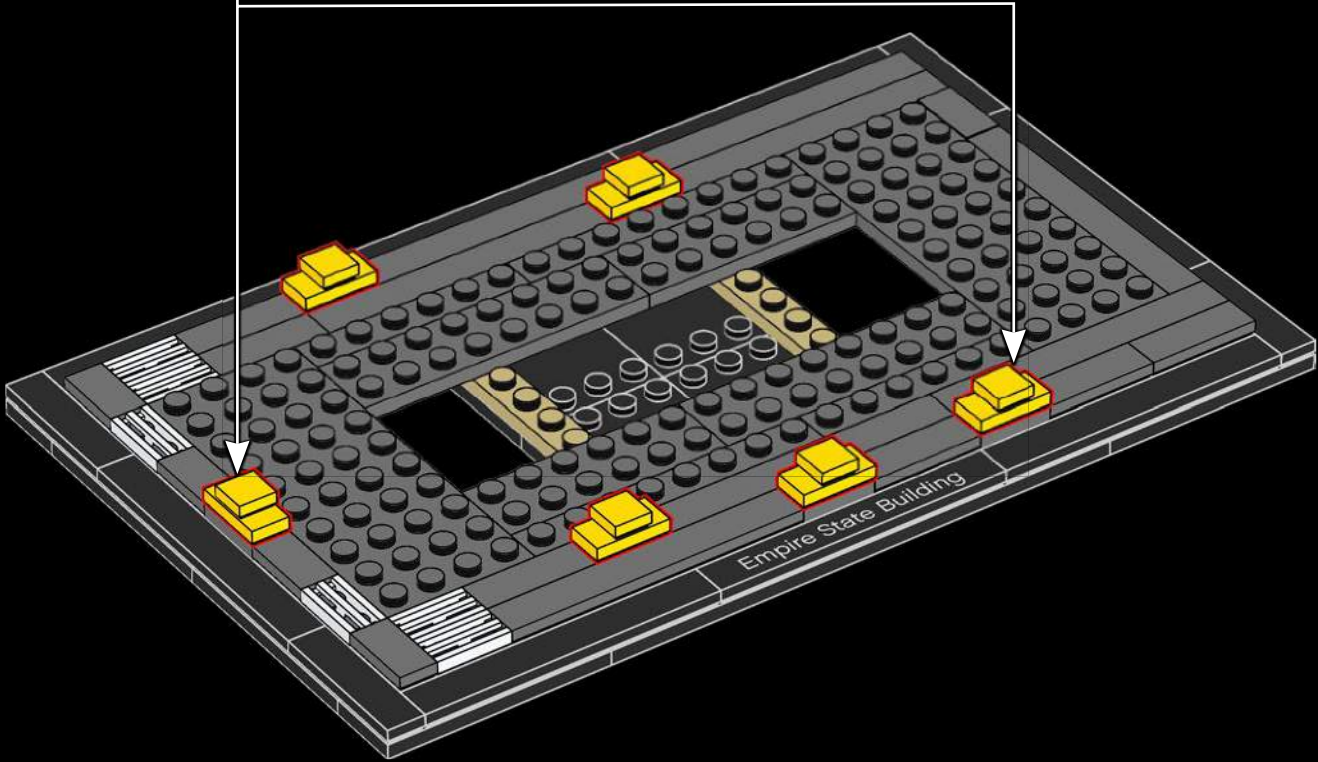
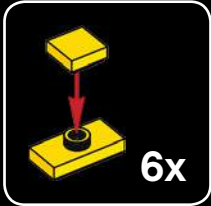

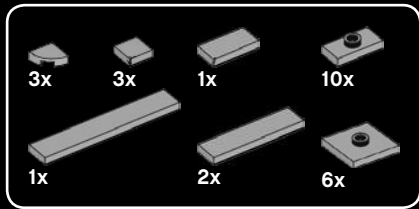

# 15

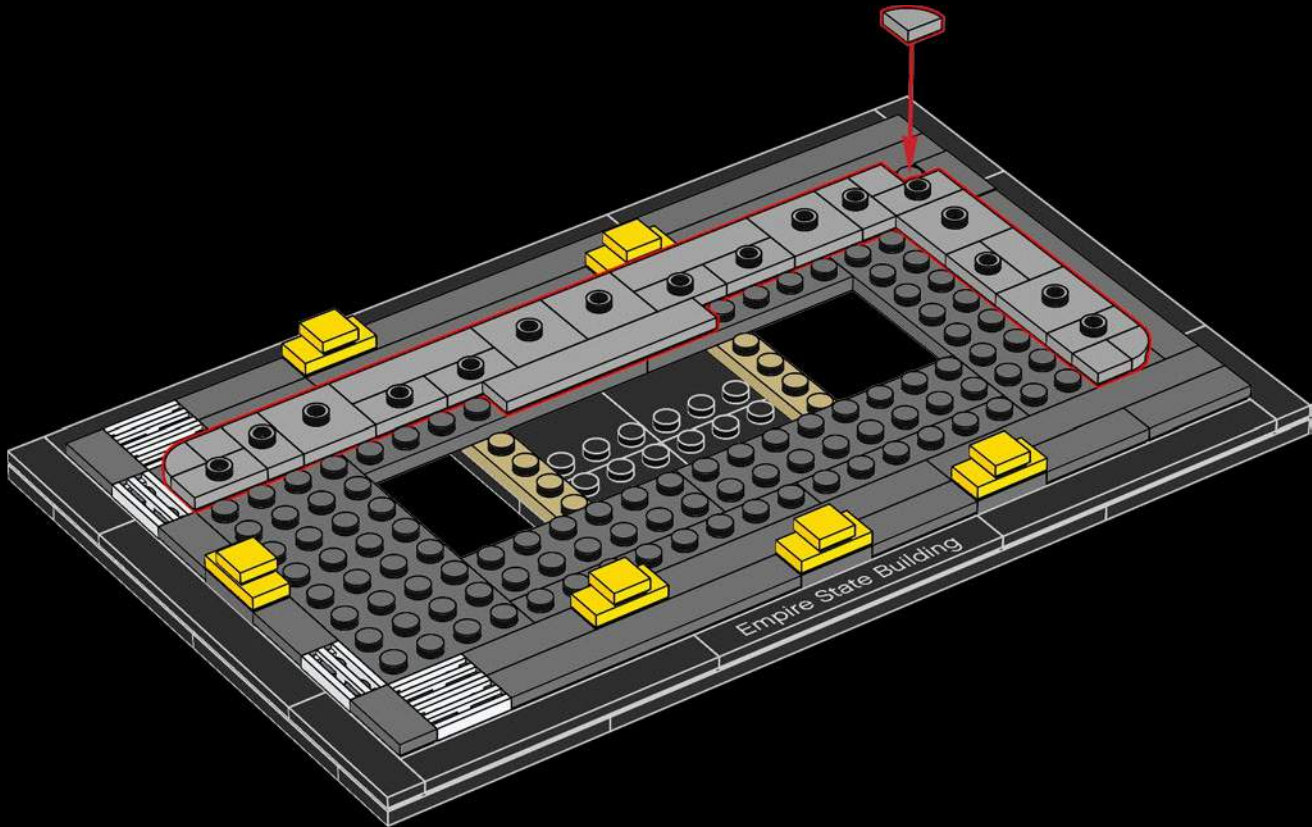

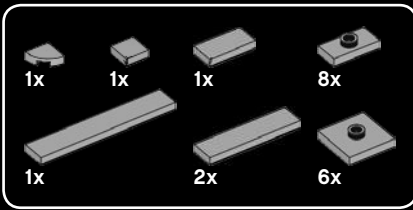

16

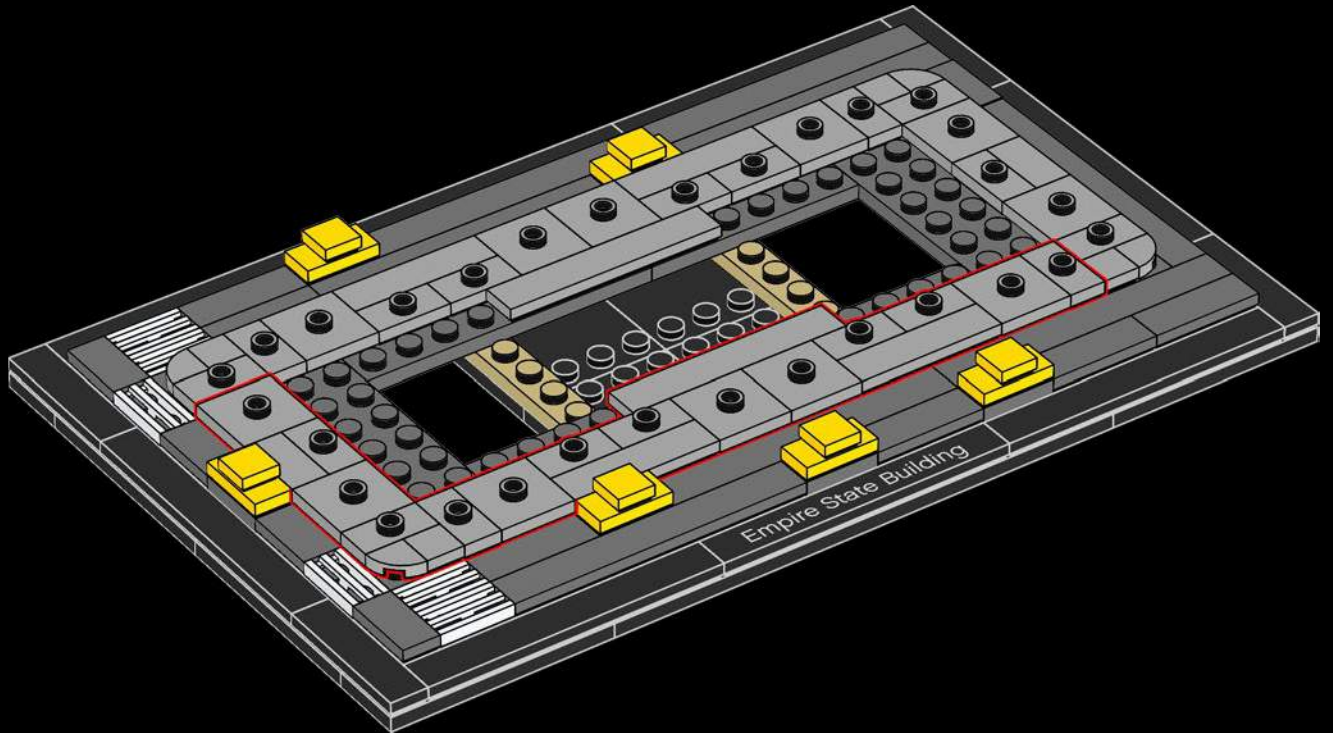



17

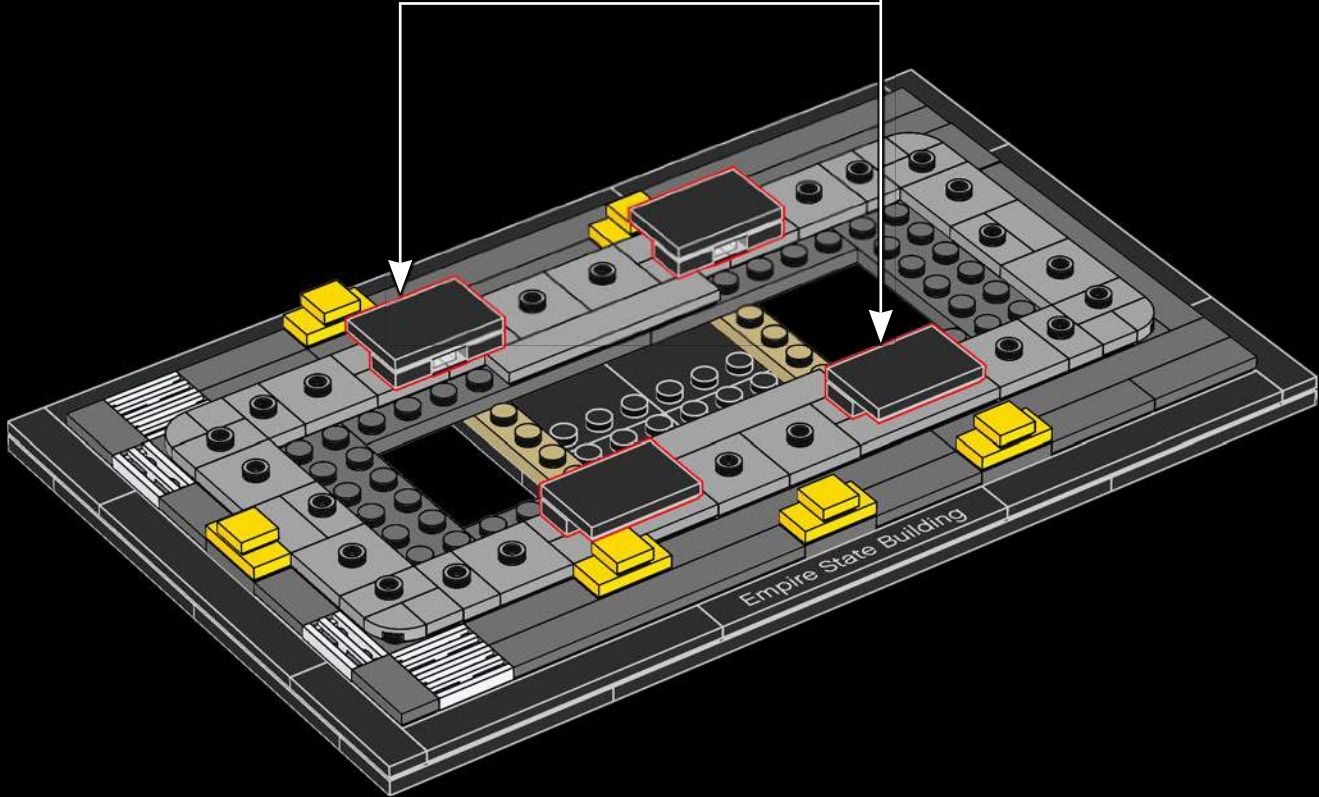
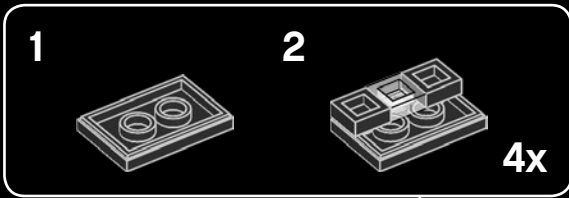

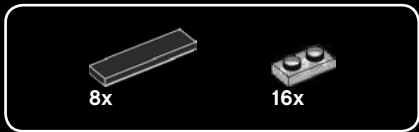

18

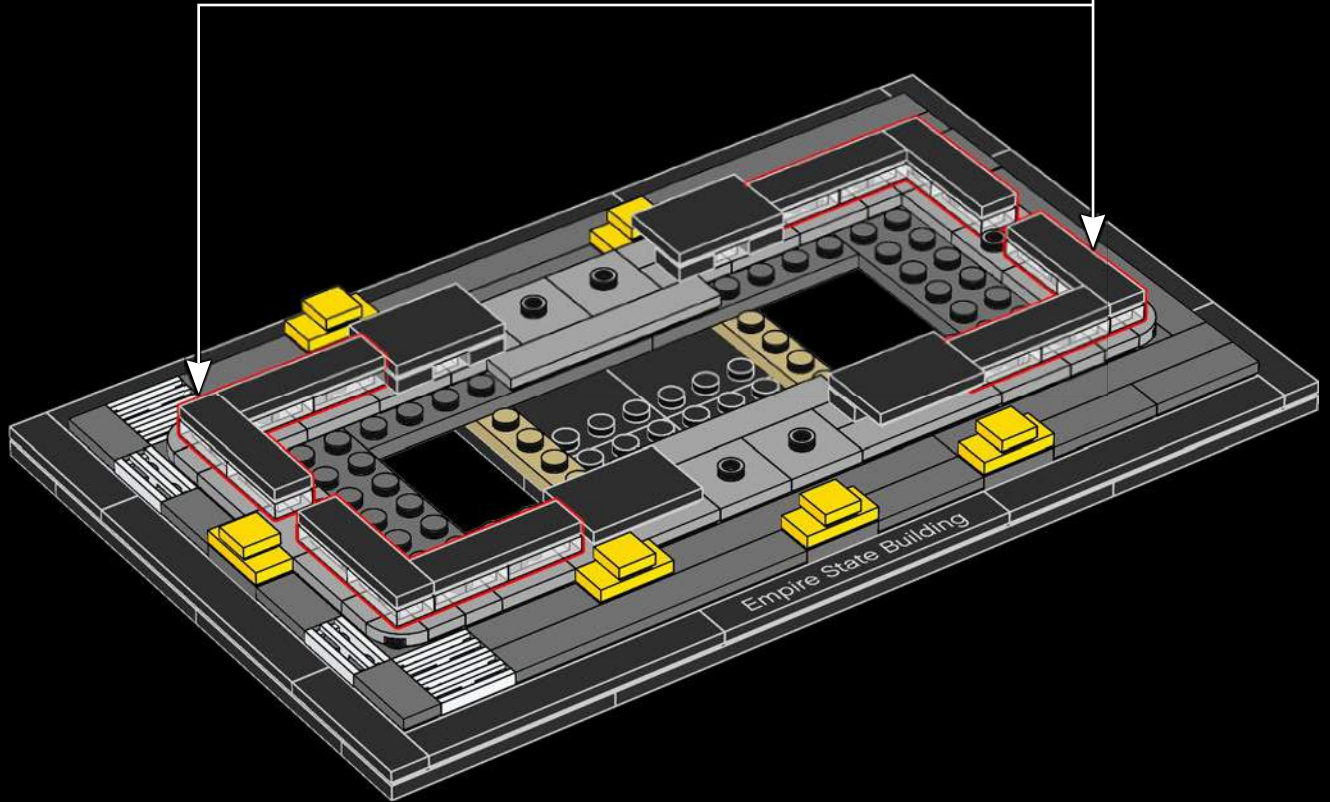
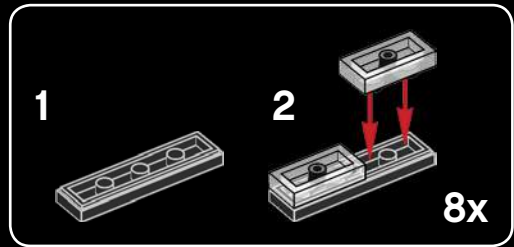



2x



2x

Running parallel to 33rd and 34th Streets, the chapel-like, three-story-high lobby has storefronts on its north and south sides.



19



2x

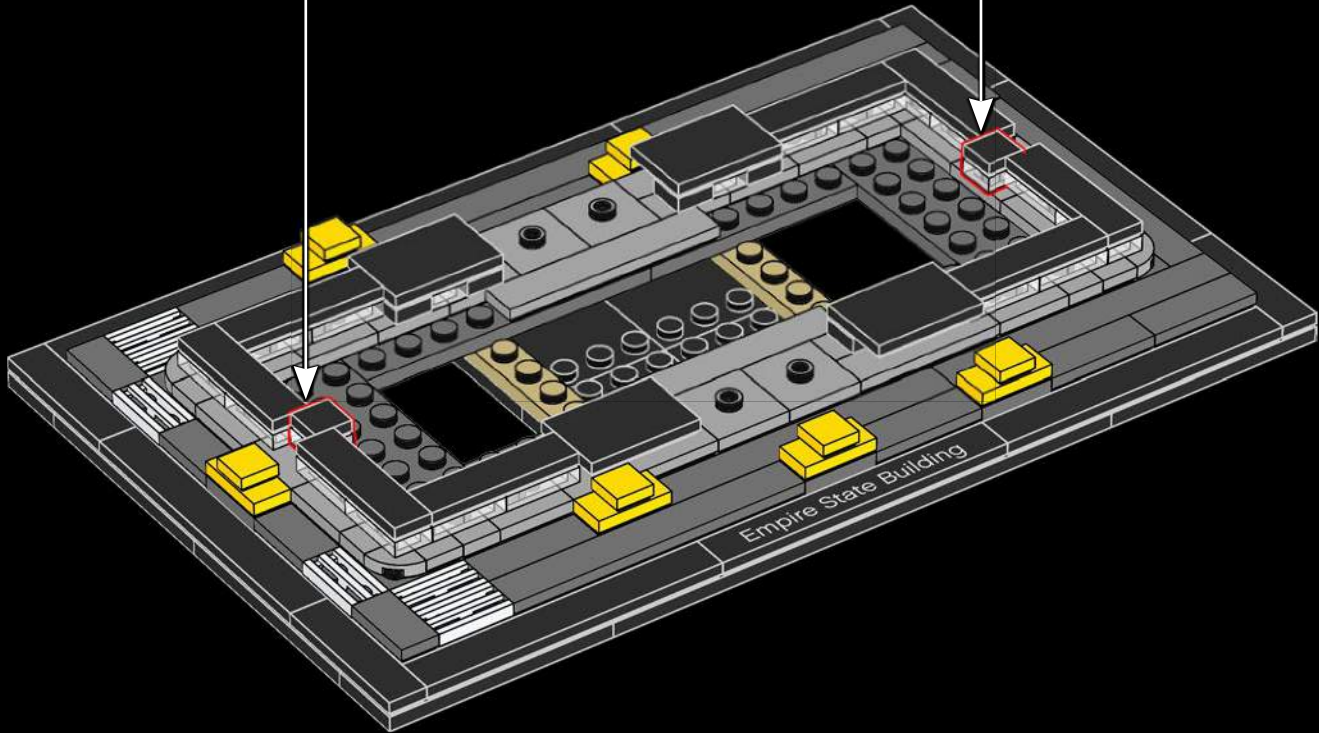



20

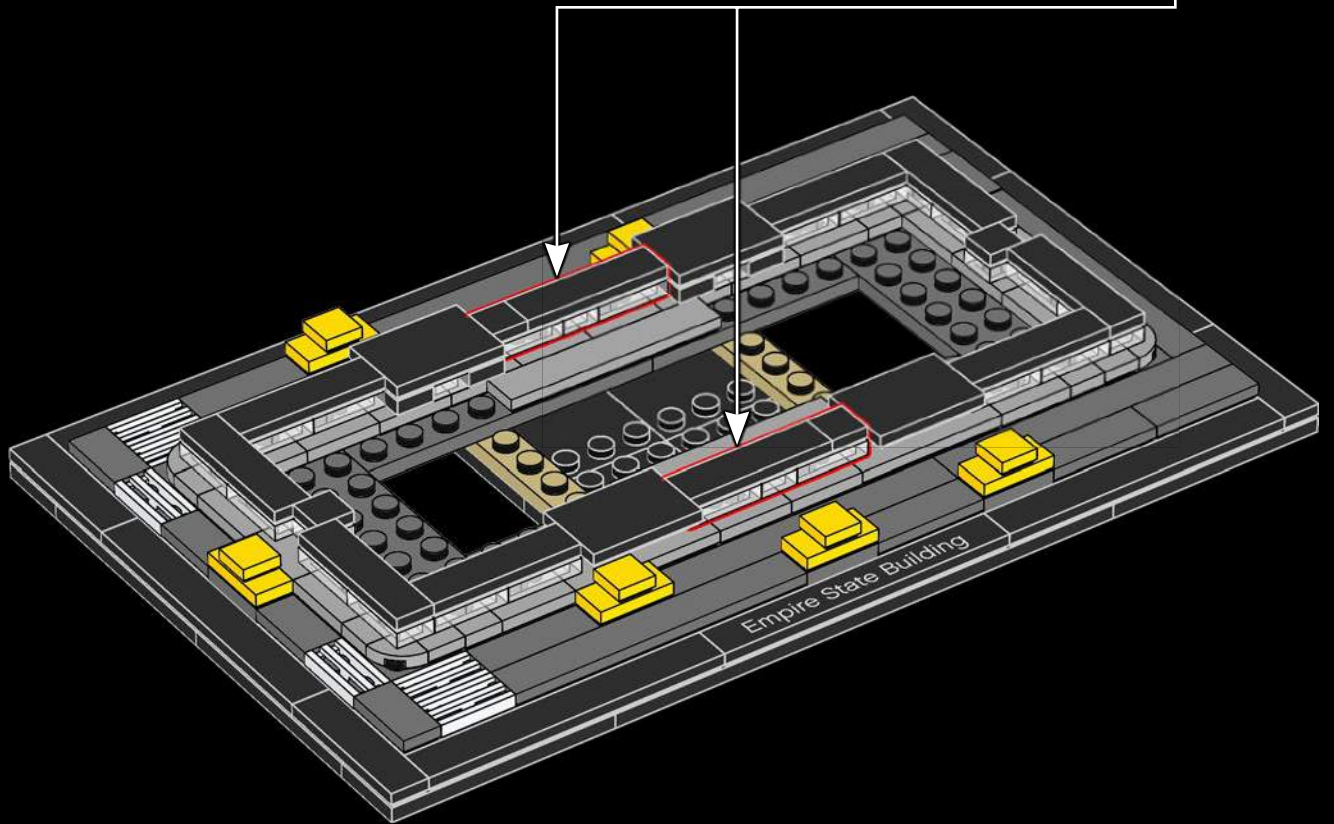
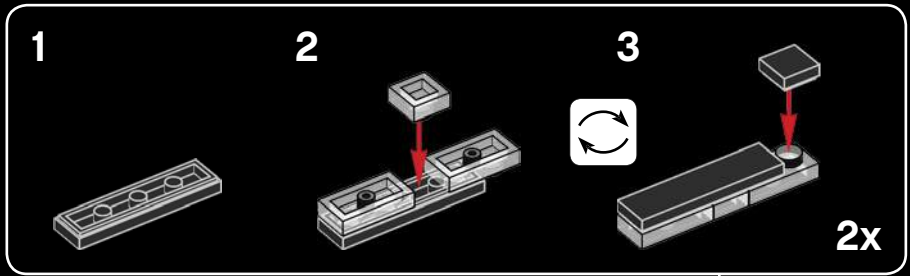

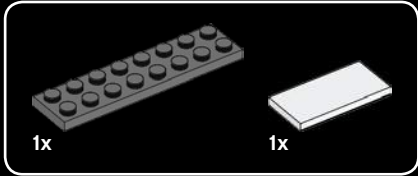

21

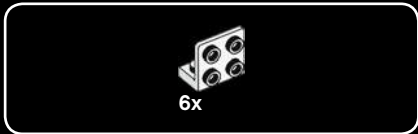
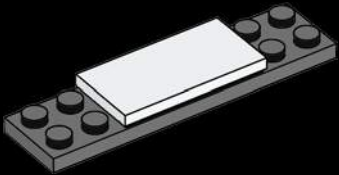

22

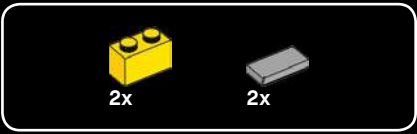
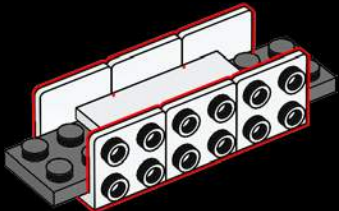

23

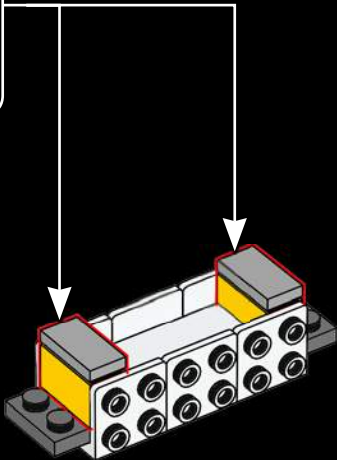
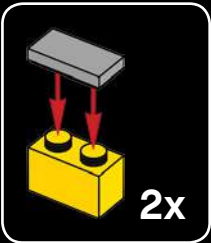



2x



6x

# 24

1



2

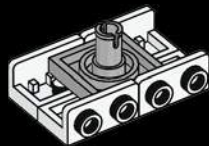

3

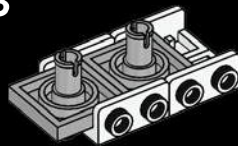

4

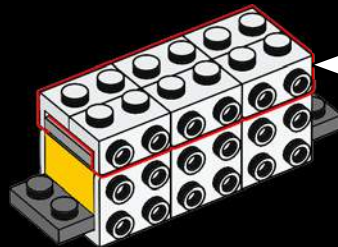
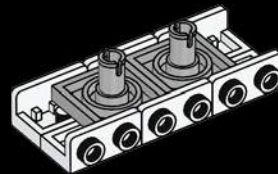

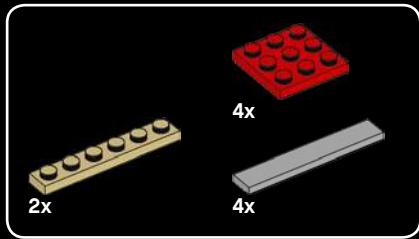

25

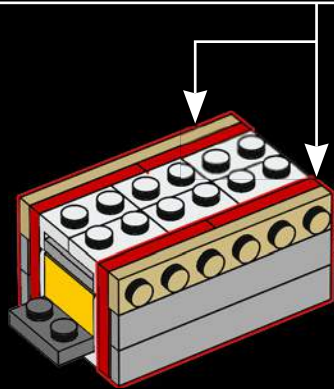
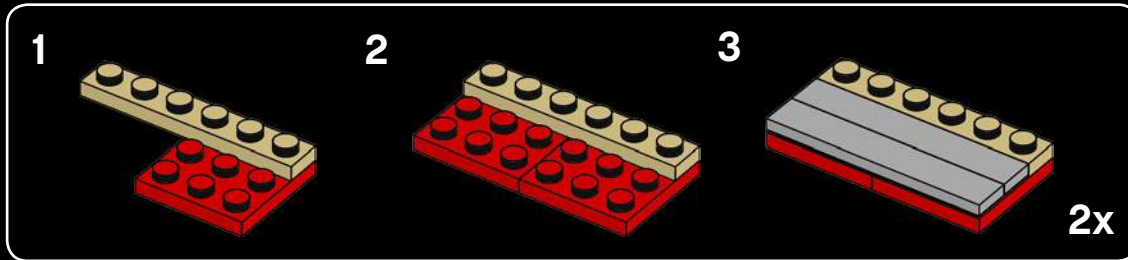

The Empire State Building has 68 modernized, high-speed elevators that transport passengers to their destinations up to 20-40% faster than conventional elevators in other modern commercial buildings. Using regenerated energy, as one elevator descends, the energy created powers the ascending elevators.



26

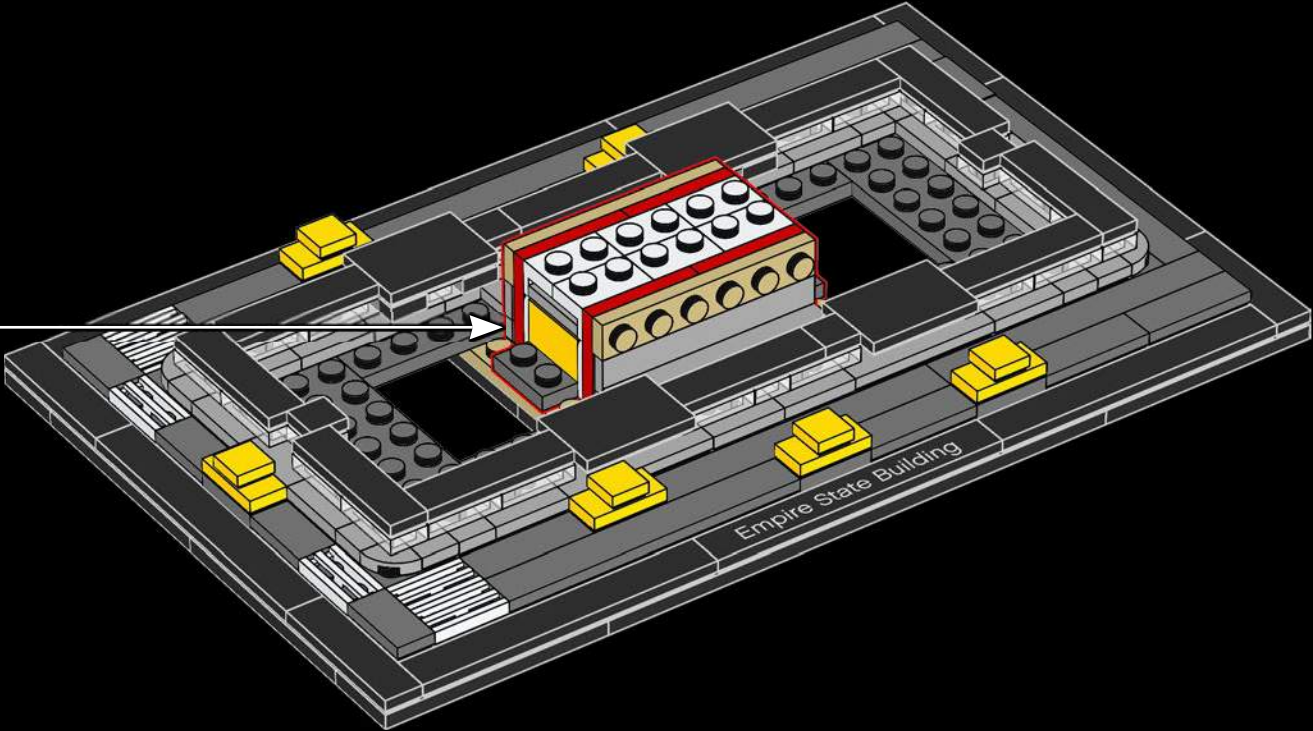

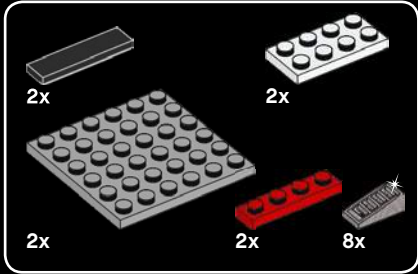

27

1

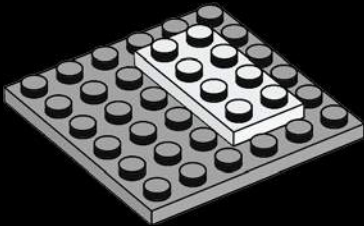

2

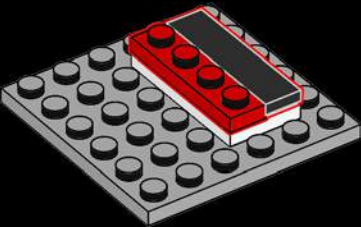

3

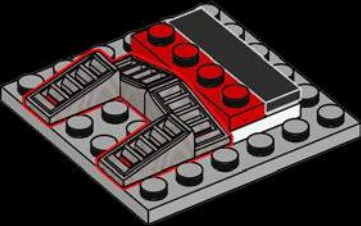

2x

There are eight high-speed escalators in the building's  
concourse and second floor areas.

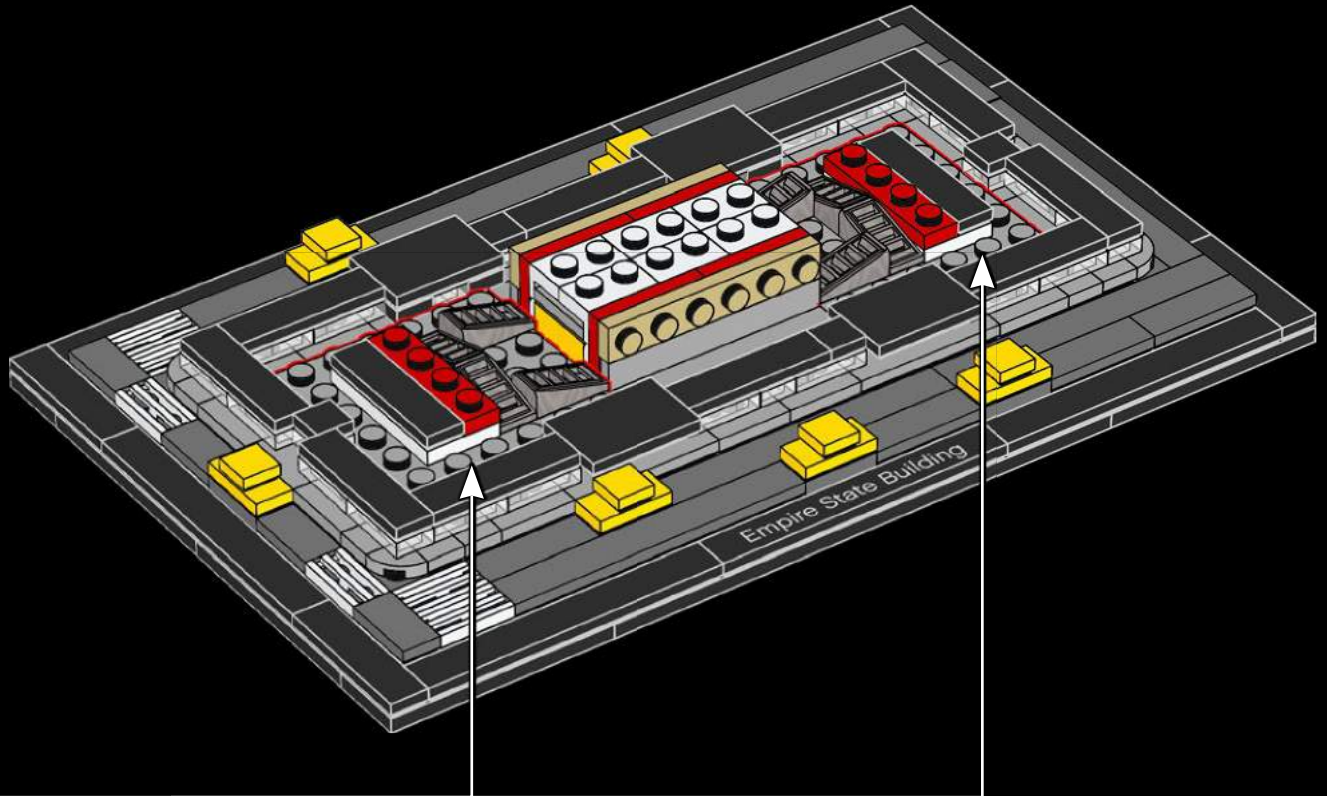

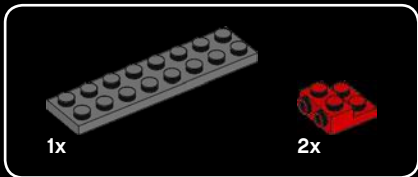
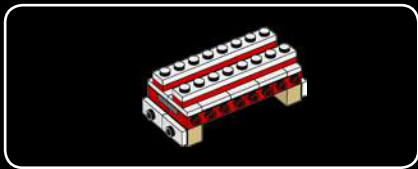

28

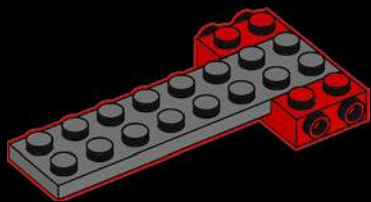

29



30

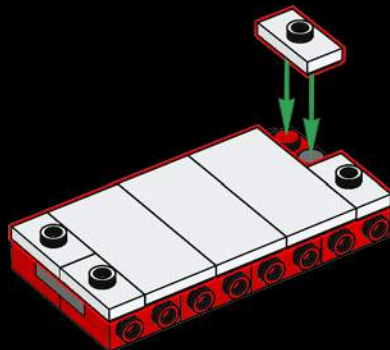

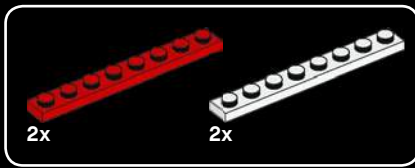

31

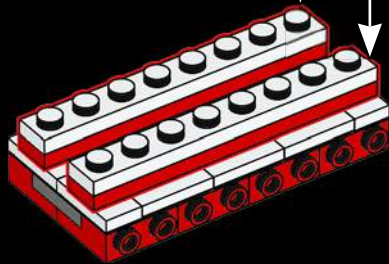
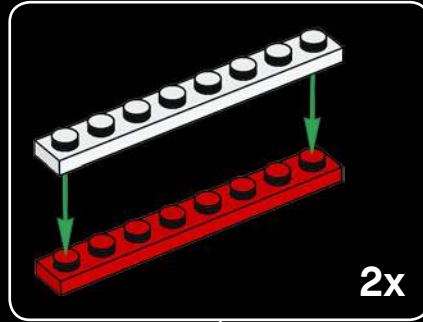

32

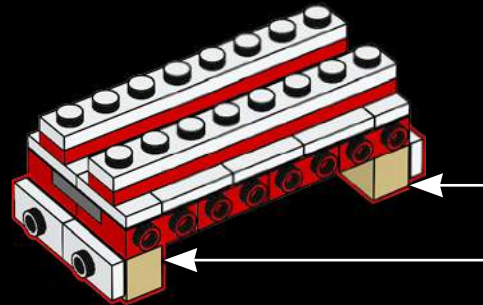
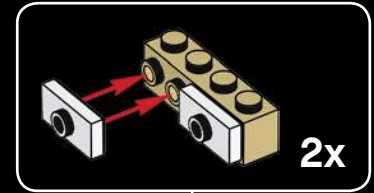

33

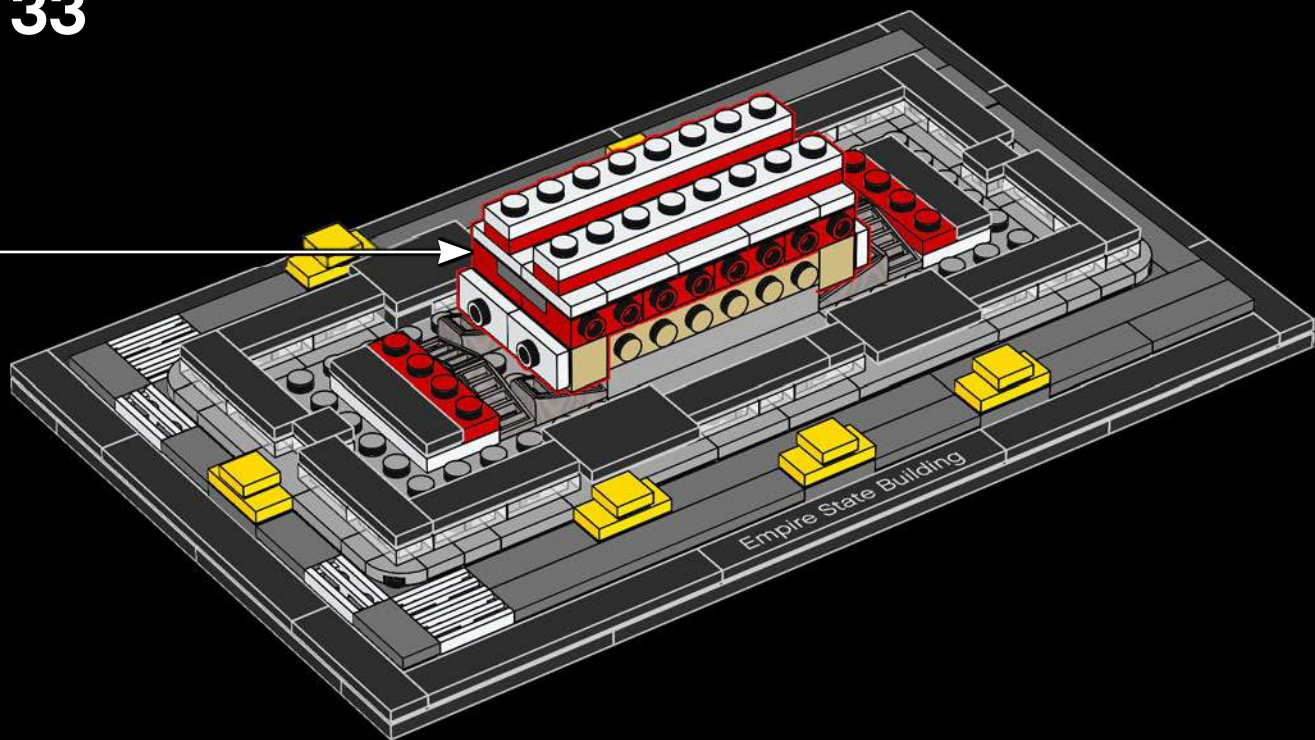

2

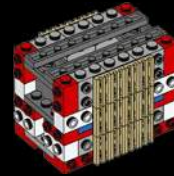
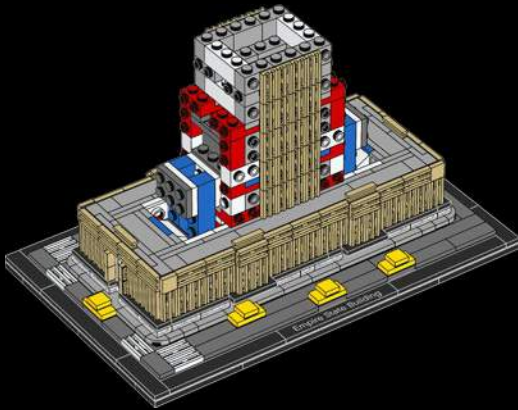

1x



2x

34



2x

35

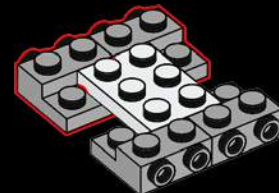



2x

36

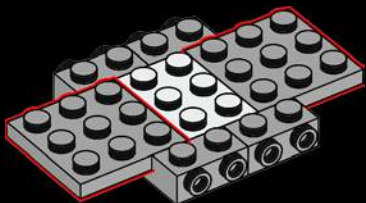

4x

37

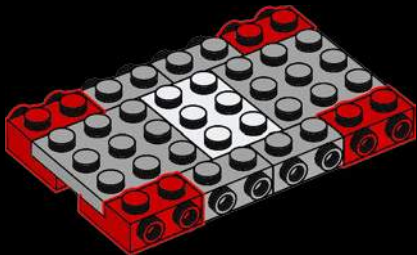

6x



4x

38

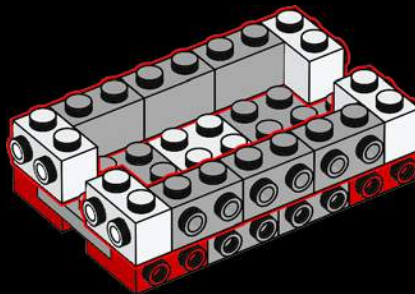

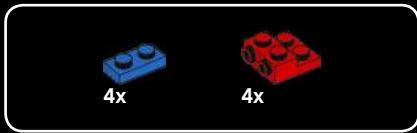

39

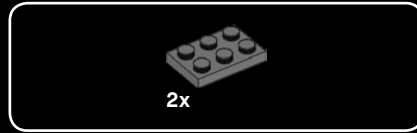
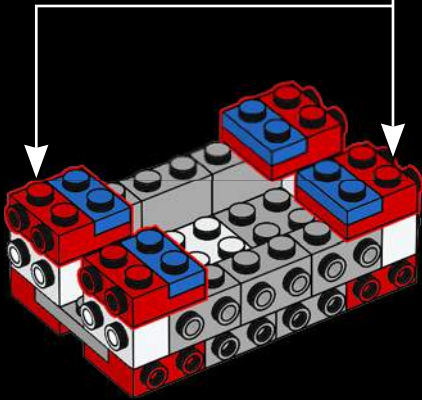
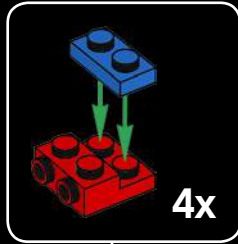

40

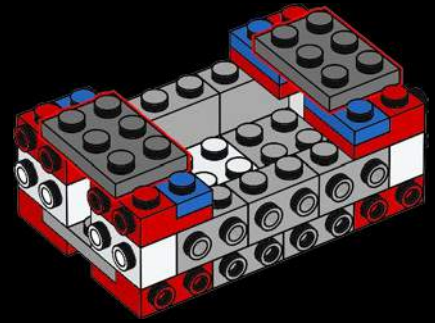



4x

41

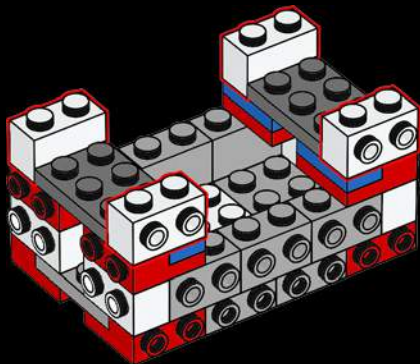

4x

42

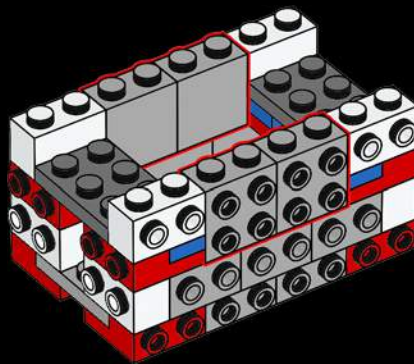

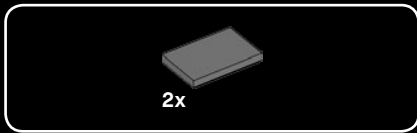

43

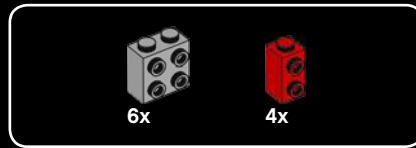
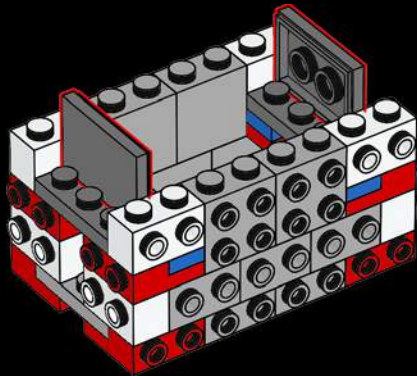

44

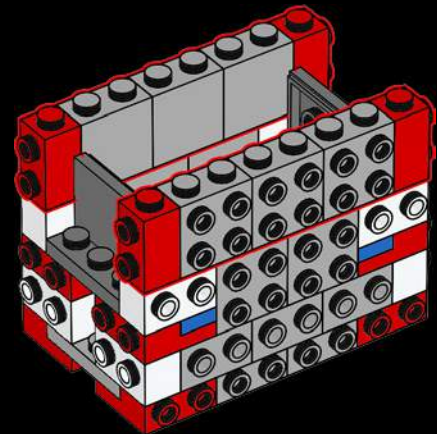

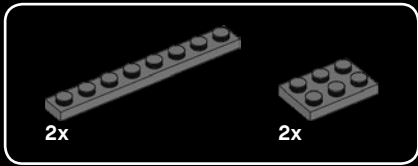

# 45

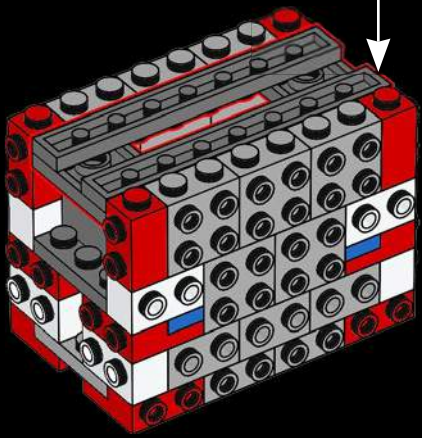
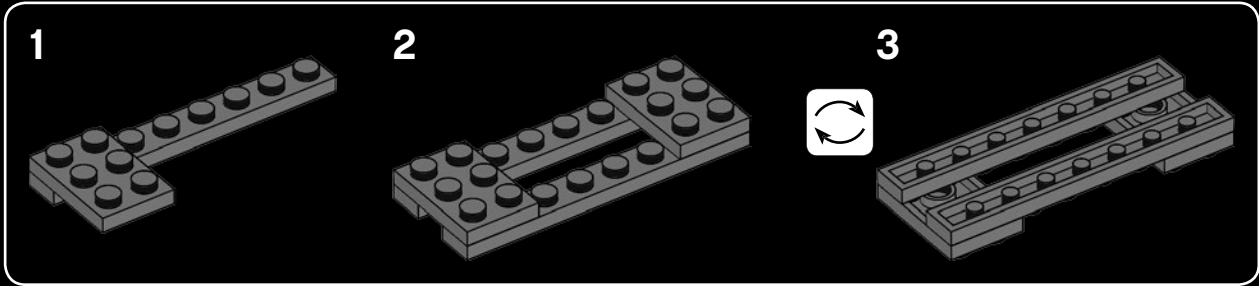



46

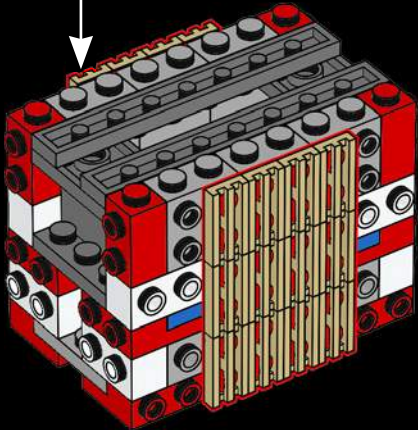

47

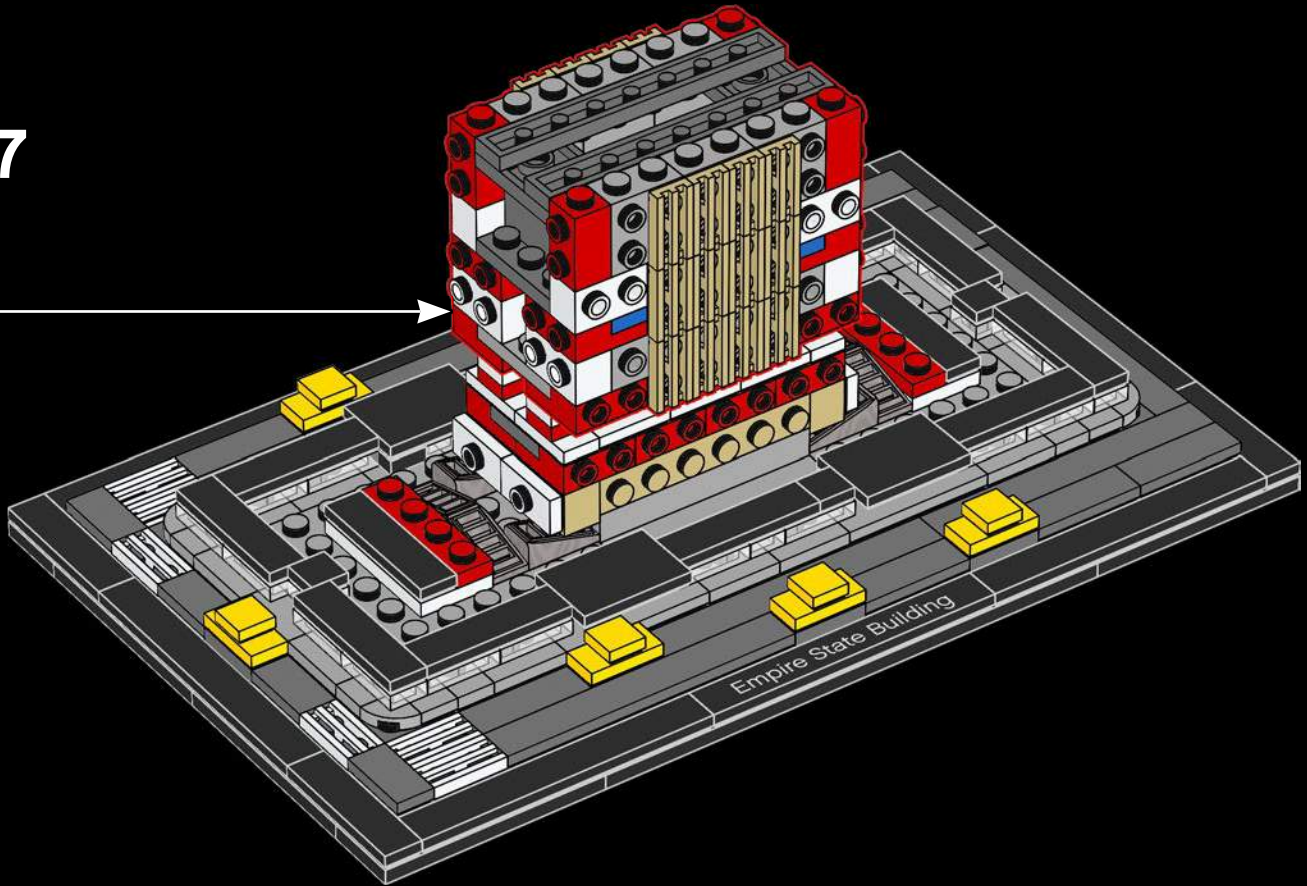

48

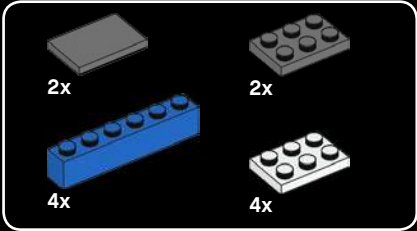

48

1

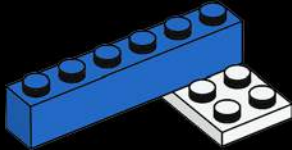

2

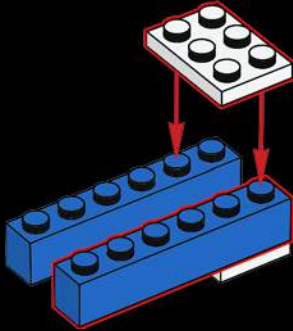

3

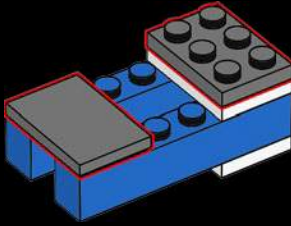

2x

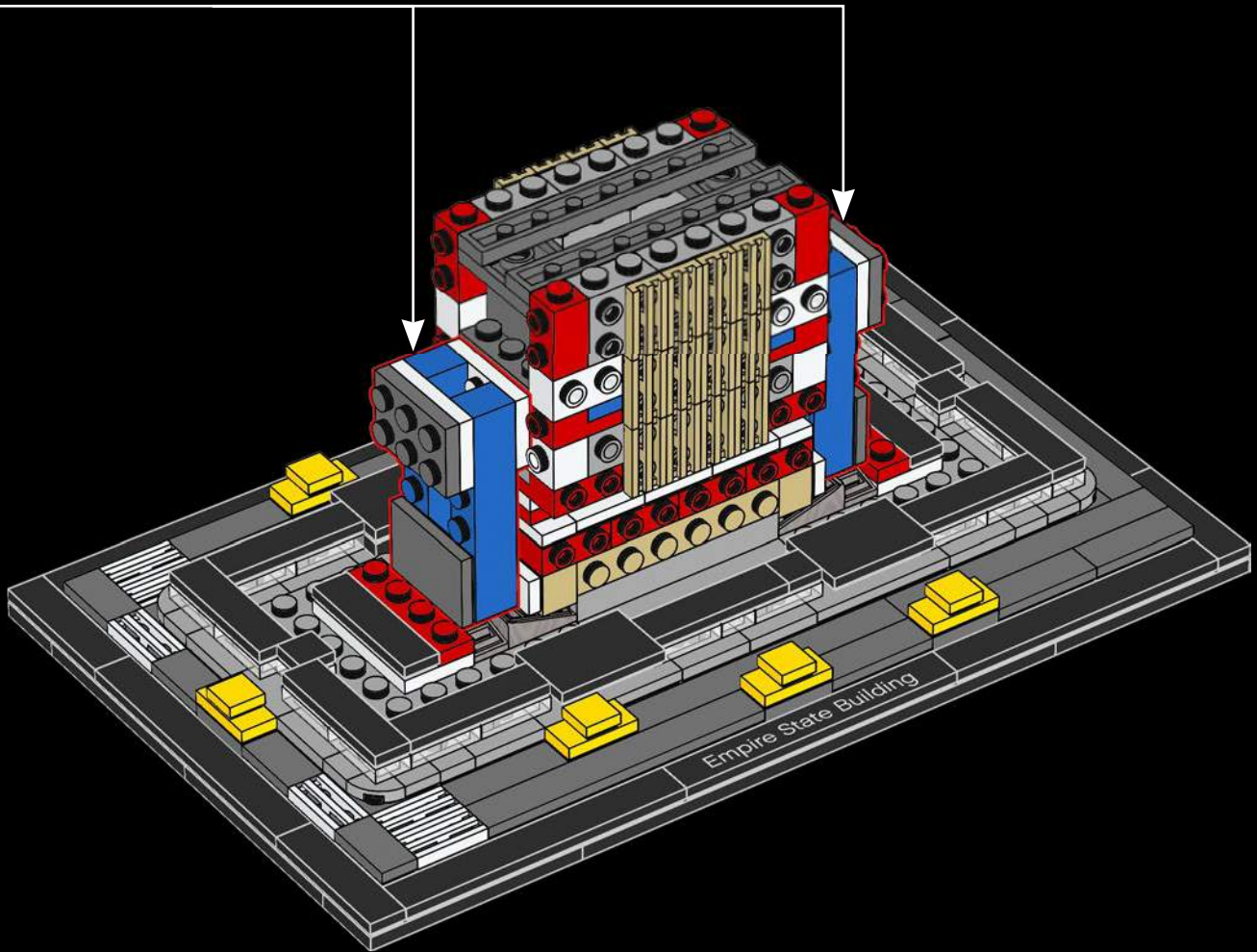

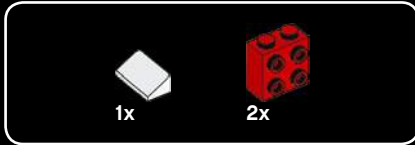
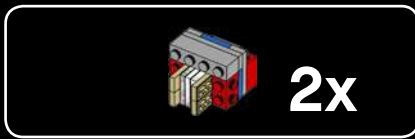

49

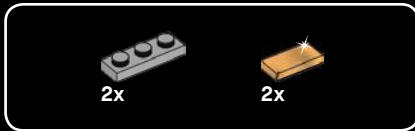
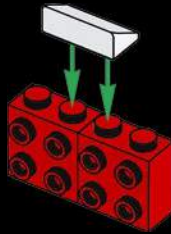

50

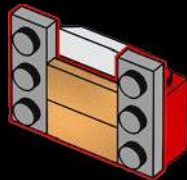

51

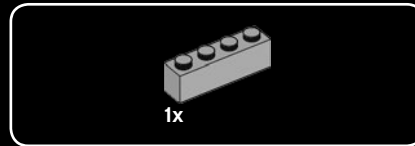
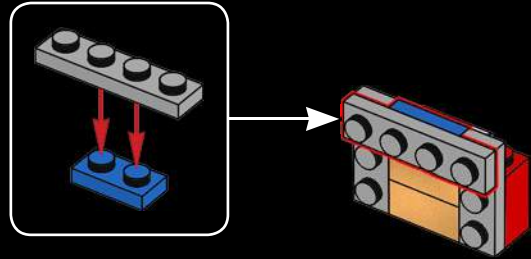

52

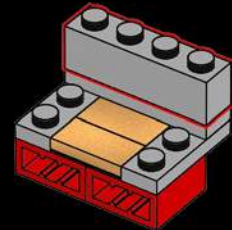
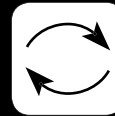



# 53

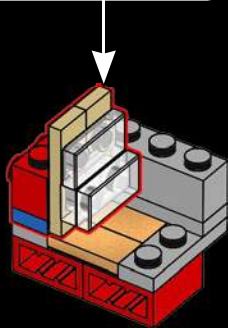
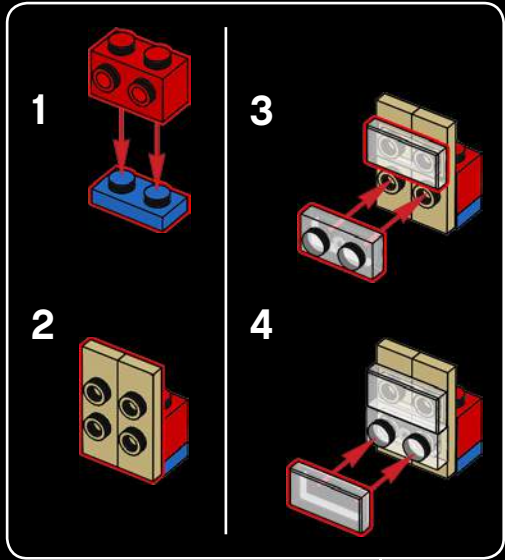

# 54

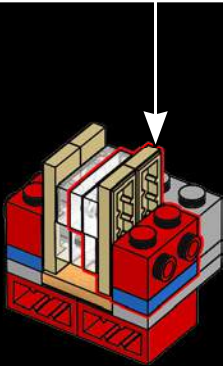
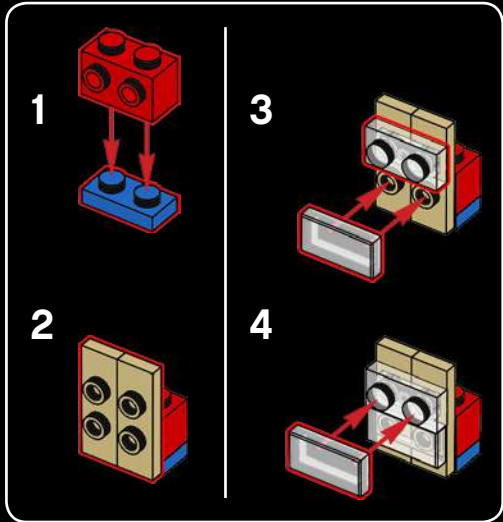

**2x**

The Famous Art Deco lobby includes an aluminum relief of the building. On the wall above the front desk in the Fifth Avenue lobby is one of the most famous images in New York City, a depiction of the building itself with beams of lights radiating from the mast.

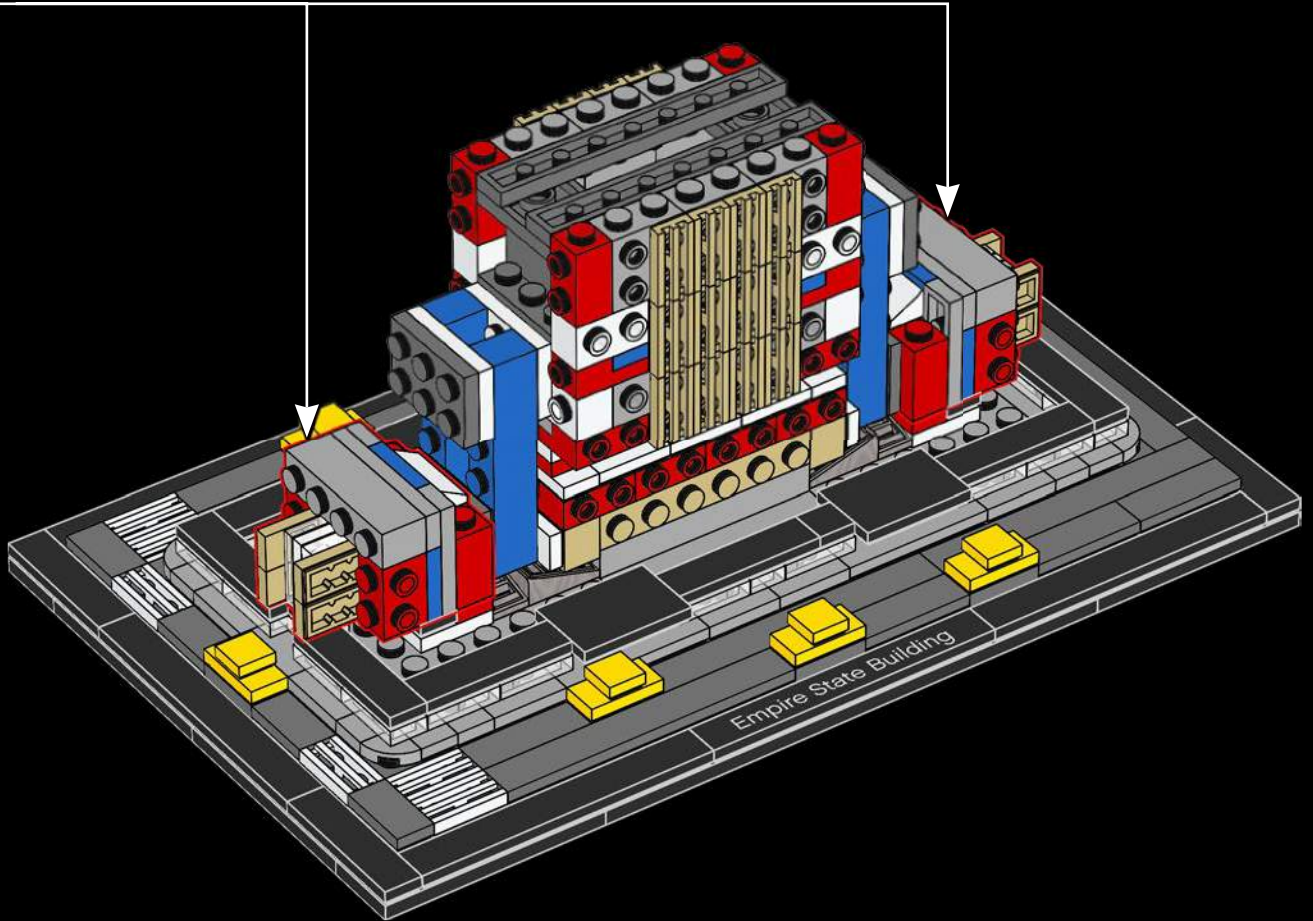

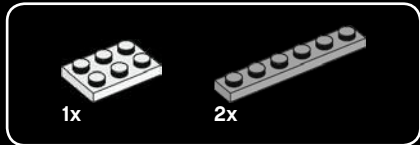
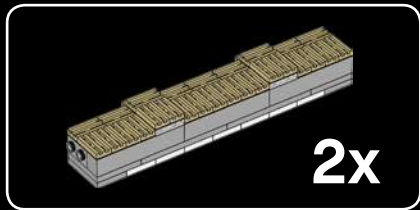

56

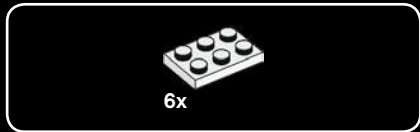
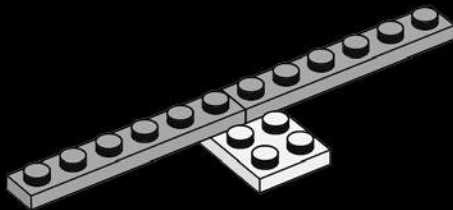

57

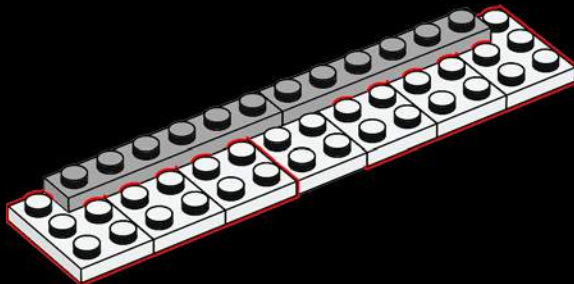

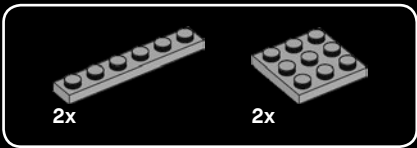

58

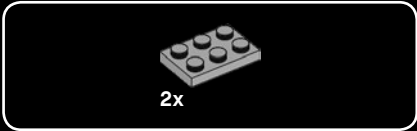
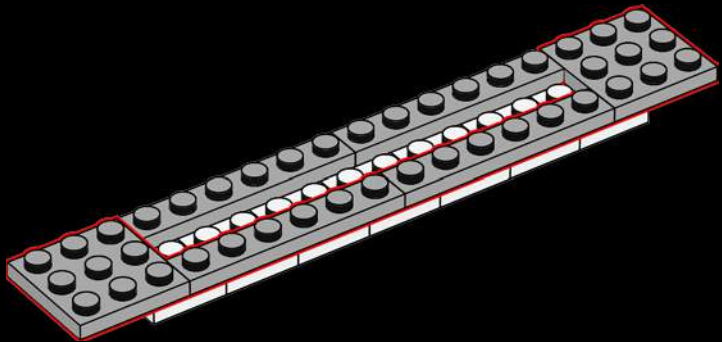

59

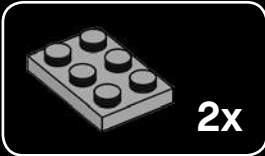
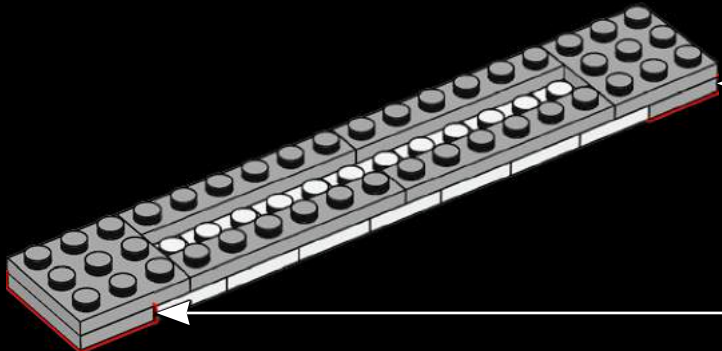

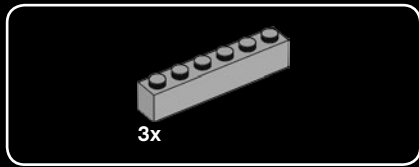

60

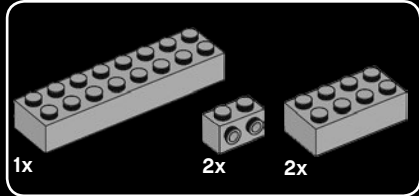
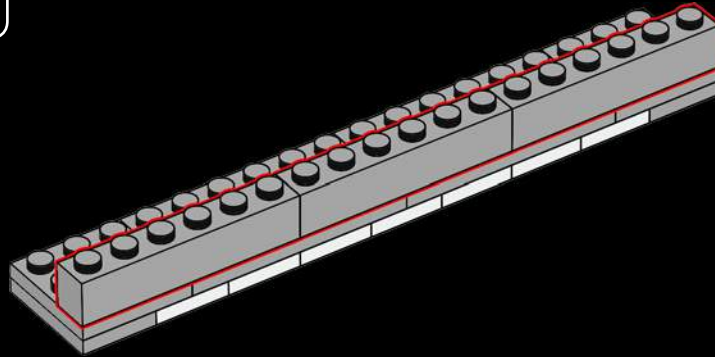

61

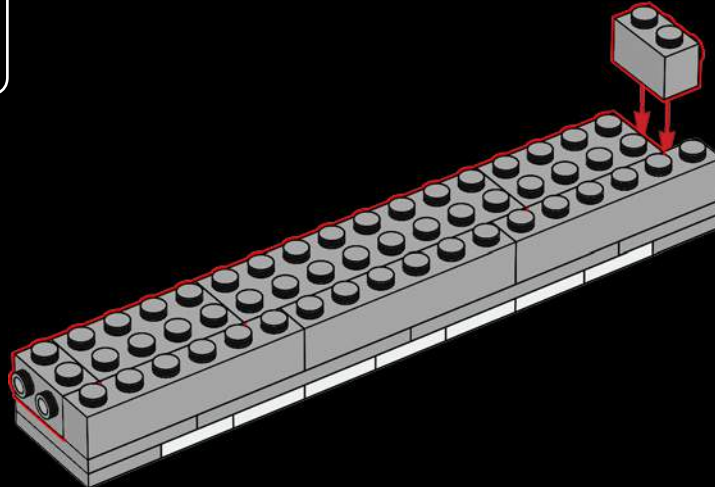



62

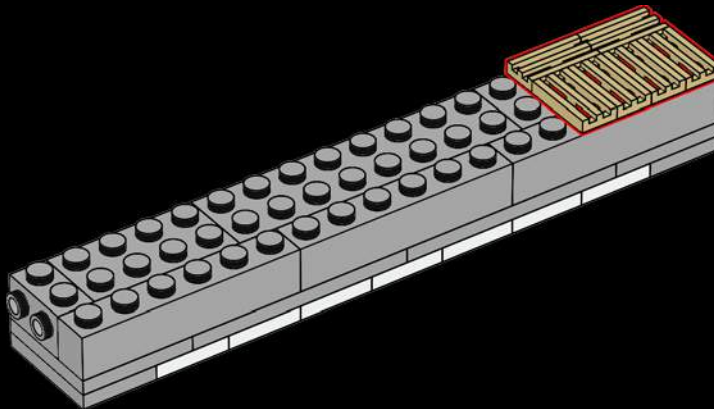

63

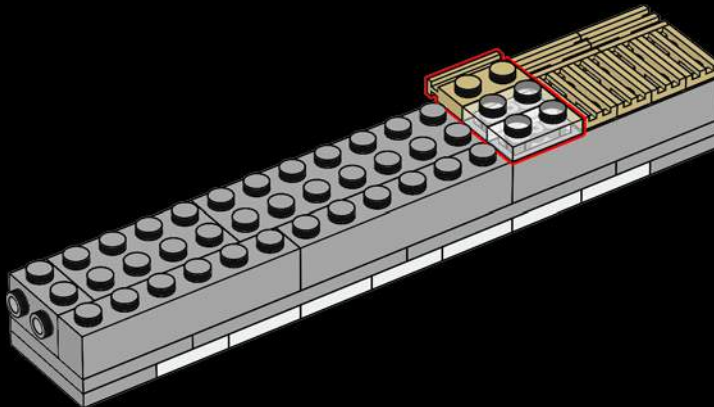



9x

64

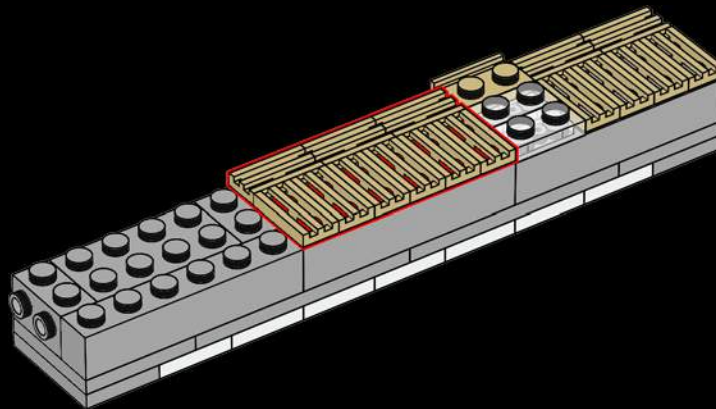

1x



2x

65

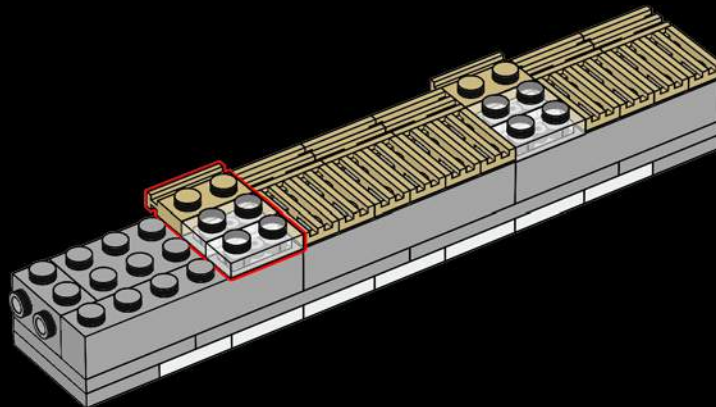



66

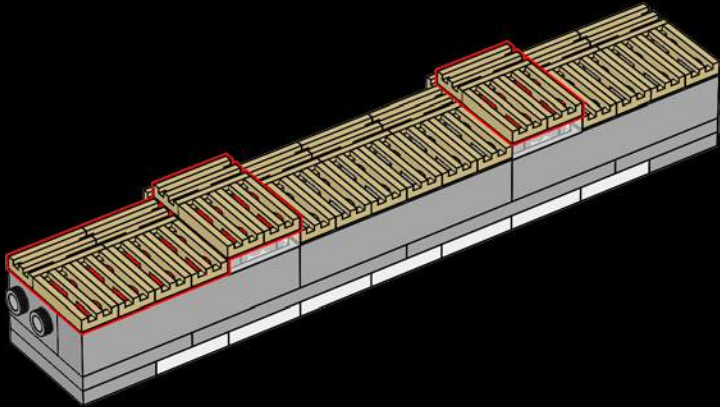

2x

67

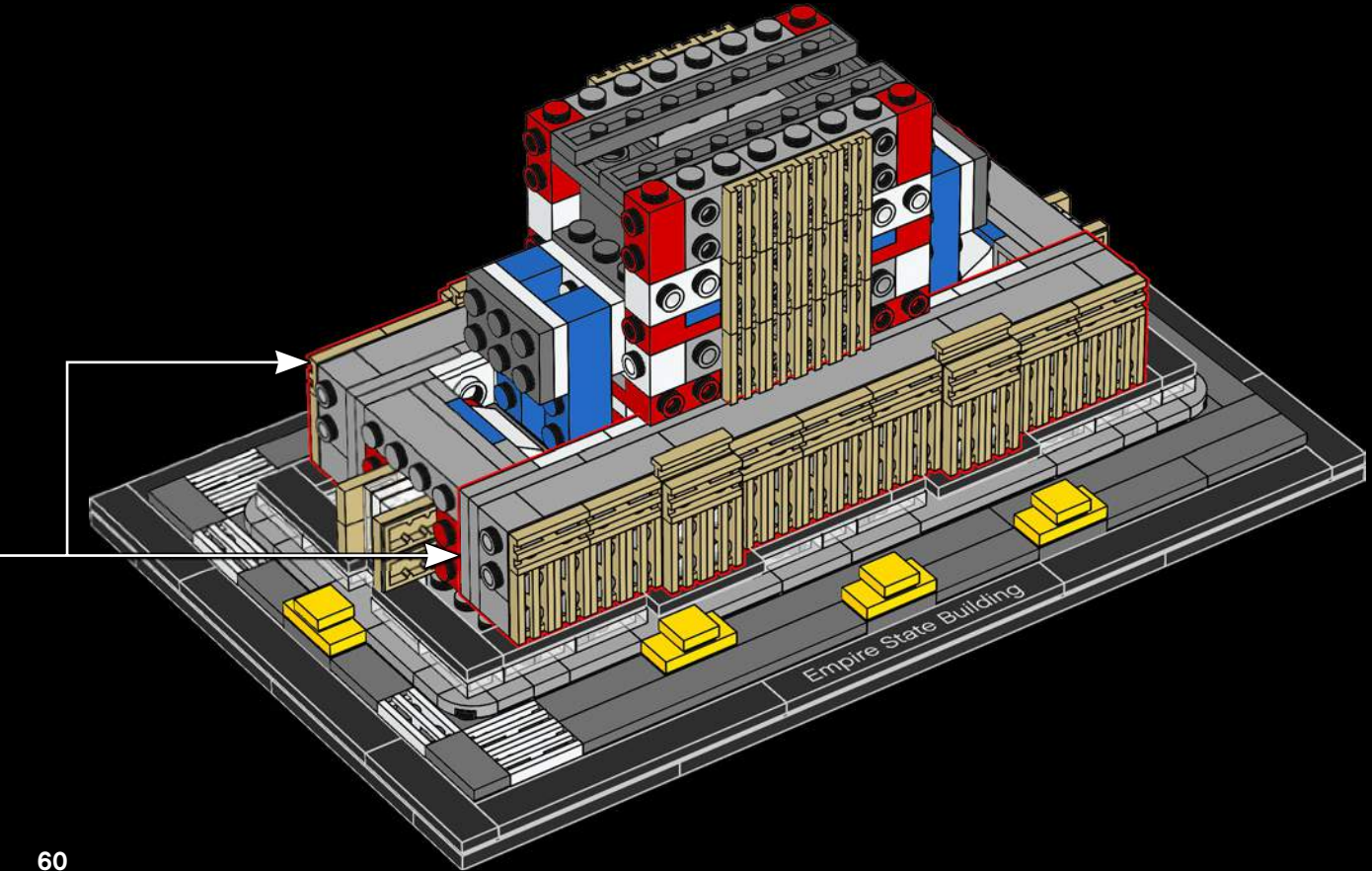

60

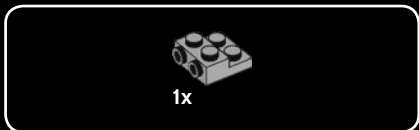

68

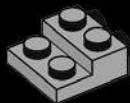

69

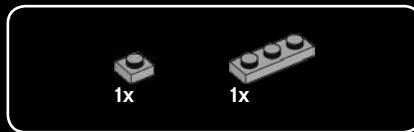

70

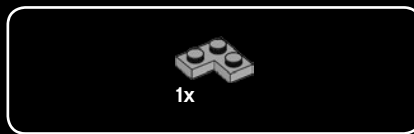
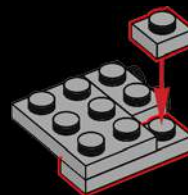

71

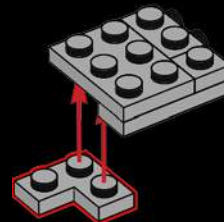



1x

# 72

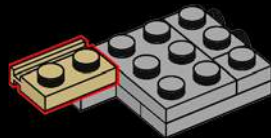

1x



1x



1x



1x

# 73

1



2



3

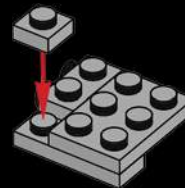

4

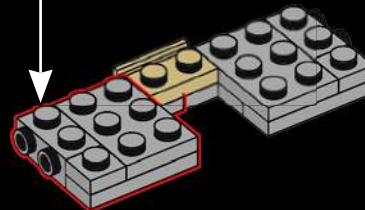
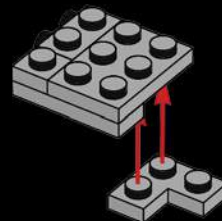

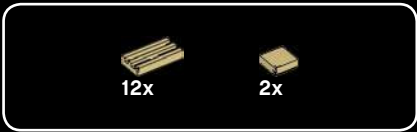

74

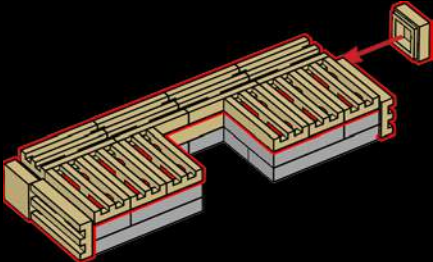

2x

75

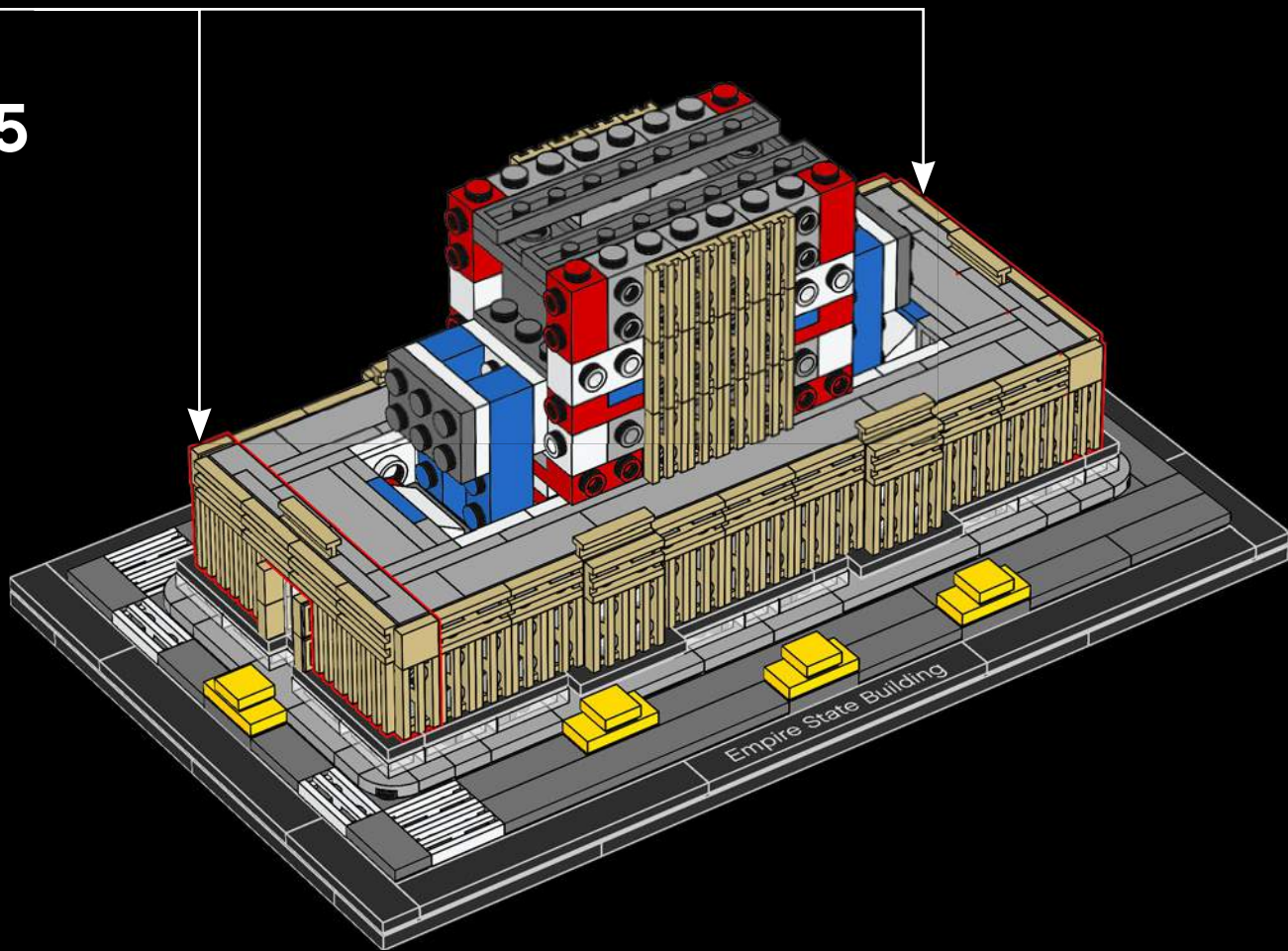

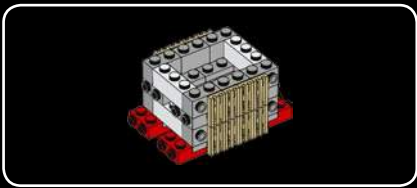

76

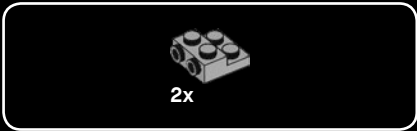
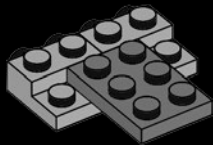

77

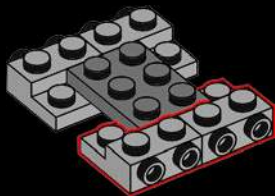

78

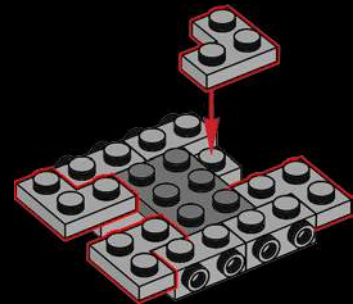

79

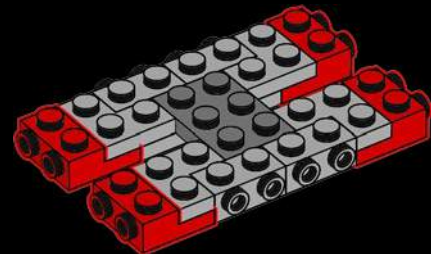

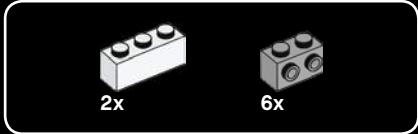

80

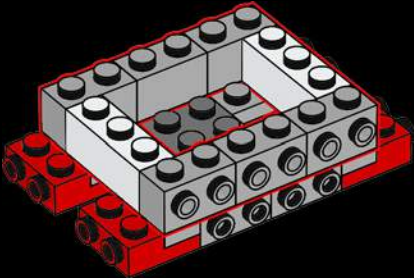

81

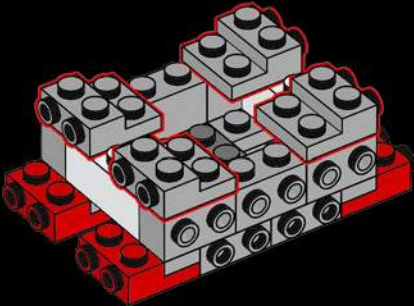



82

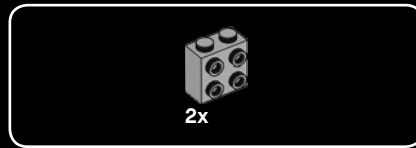
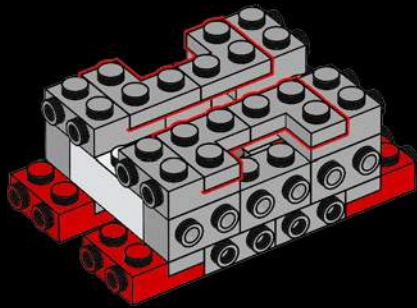

83

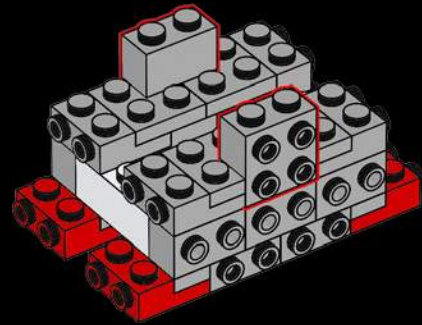

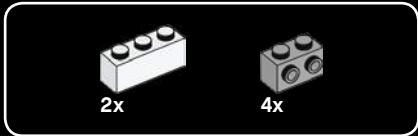

84

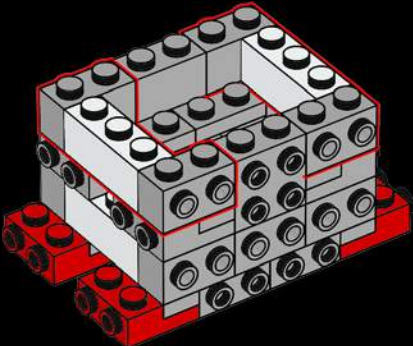

85

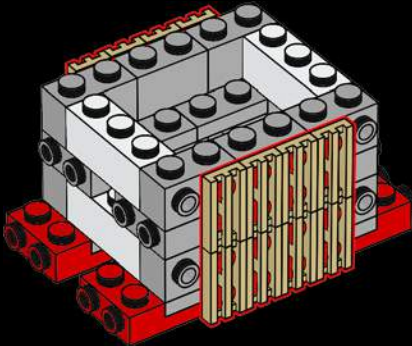

86

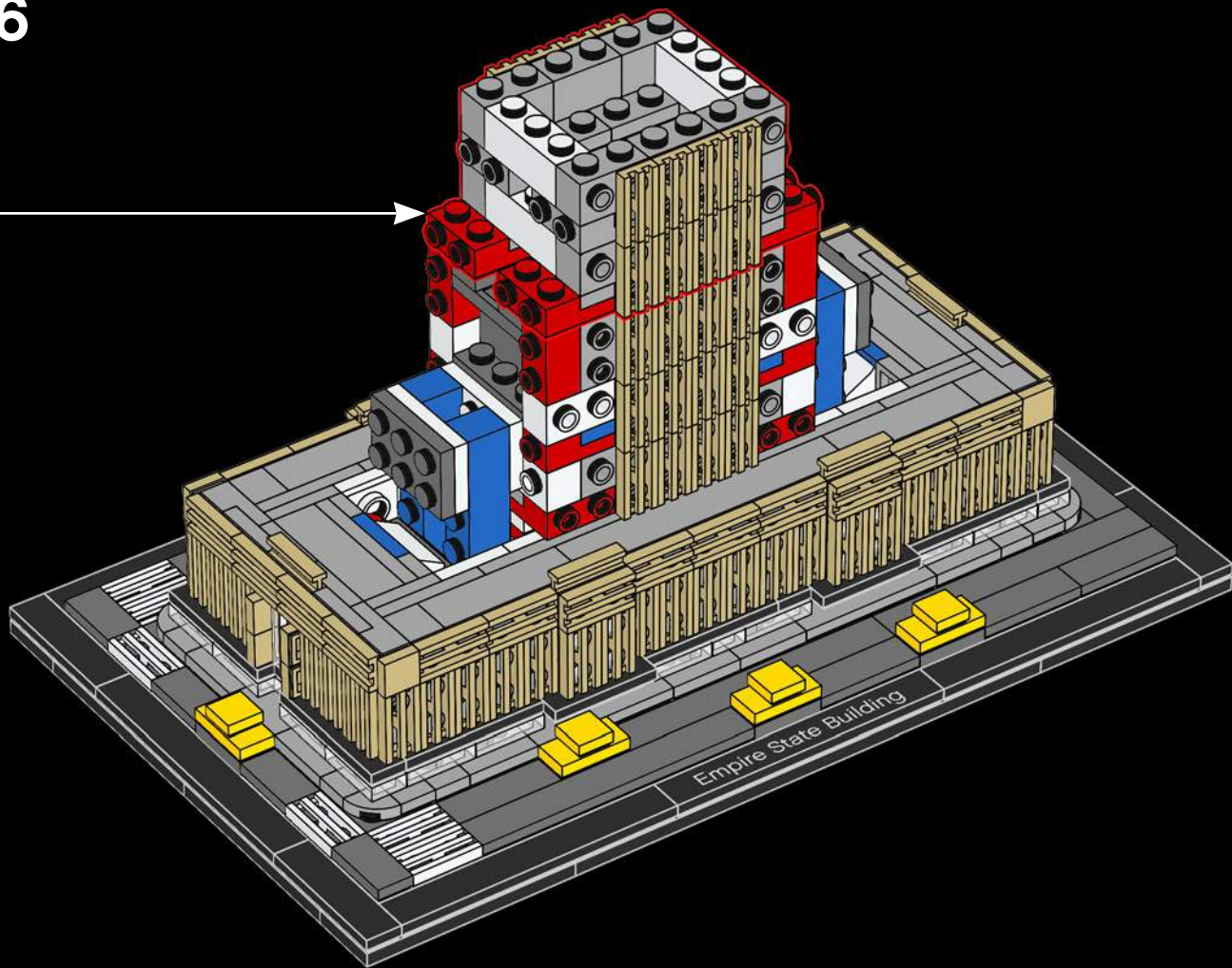

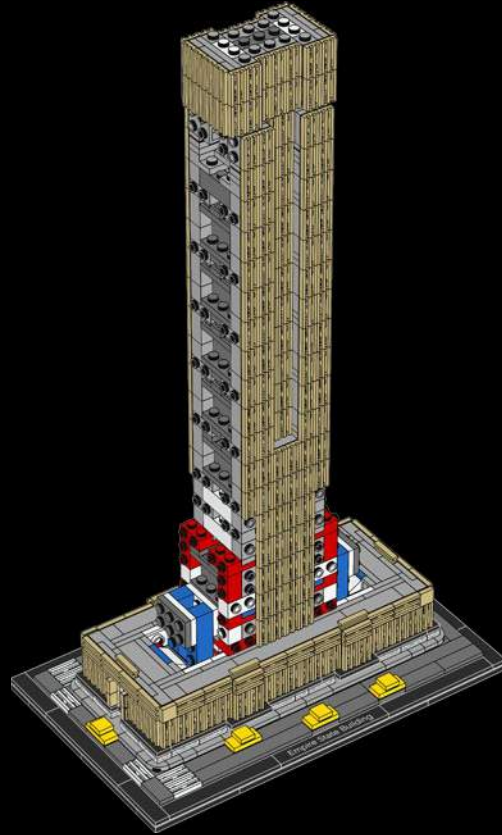

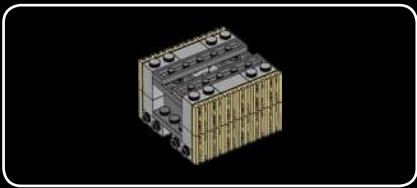

87

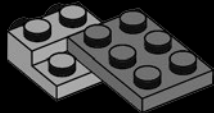

88

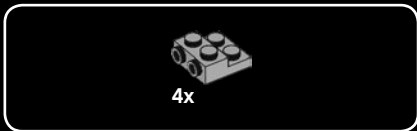
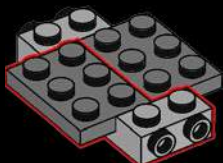

89

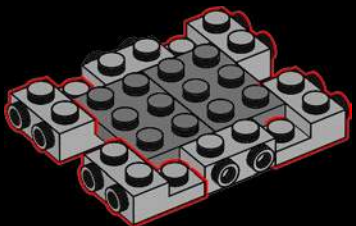

90

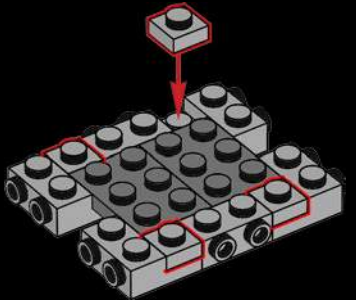



1x

91

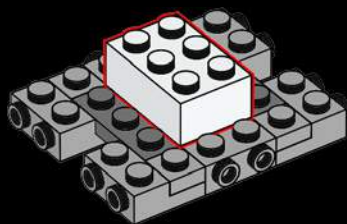

2x

92

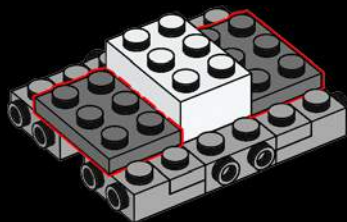

6x

93

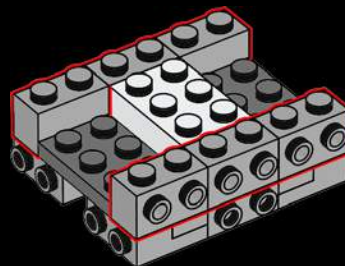

2x

94

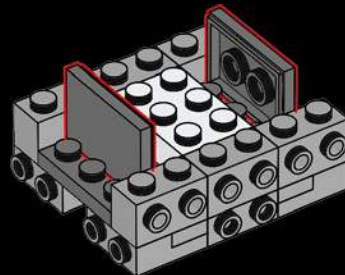

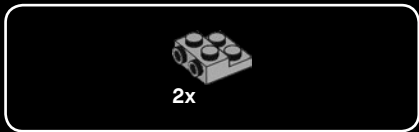

95

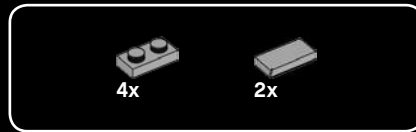
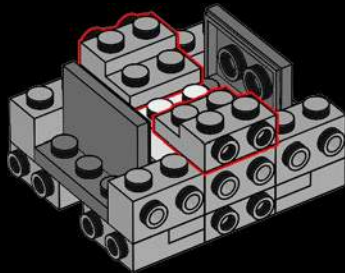

96

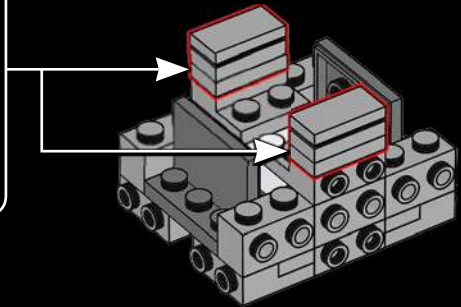
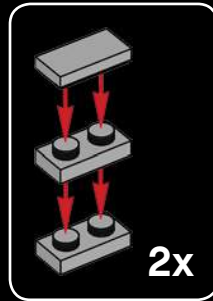



4x

97

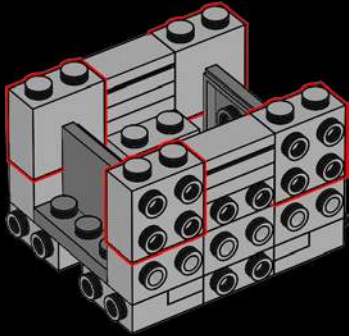

24x

98

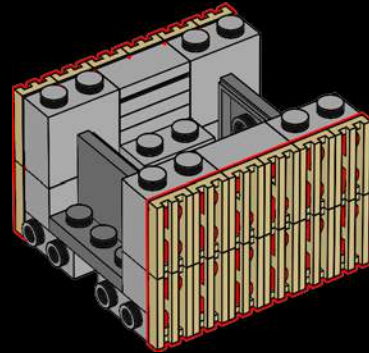

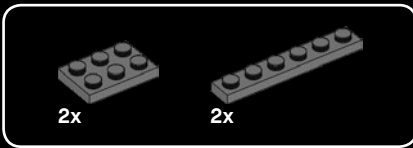

99

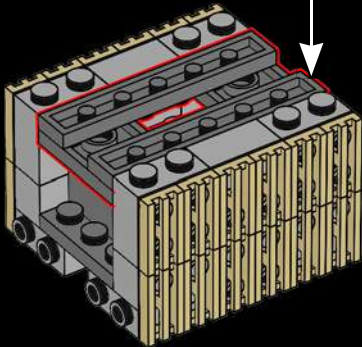
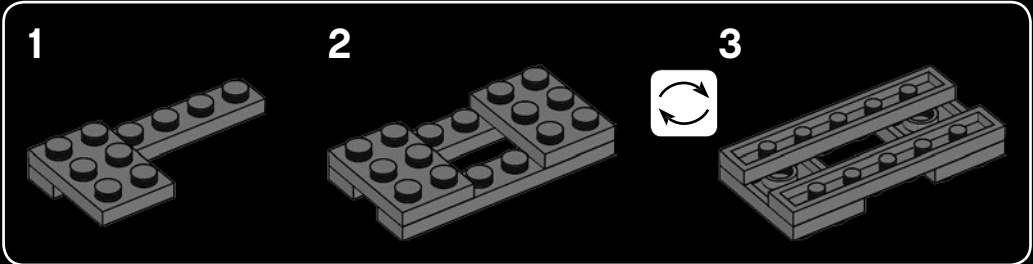

The steel frame construction of the building is made from riveted steel beams and girders.

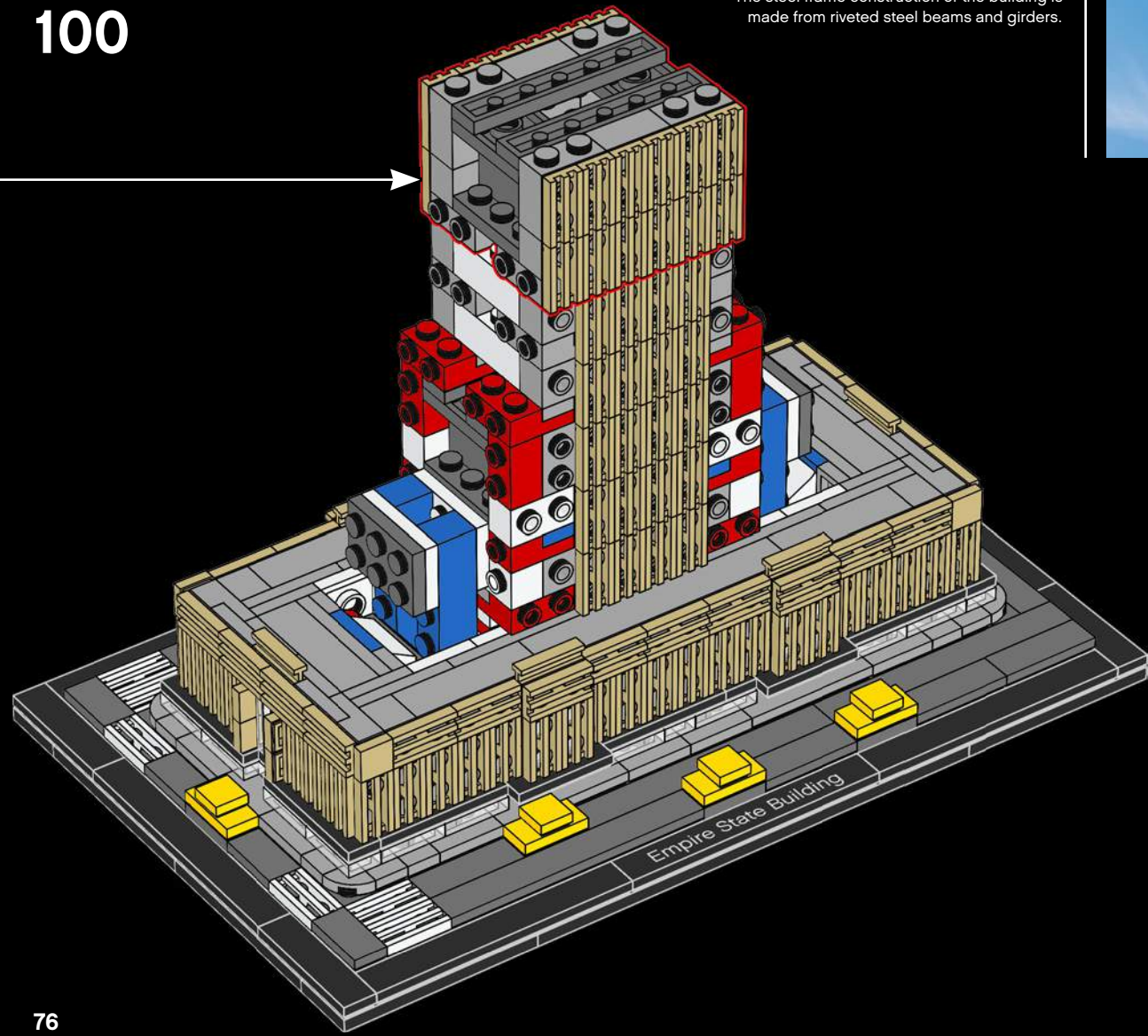

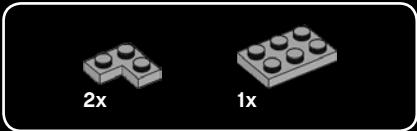
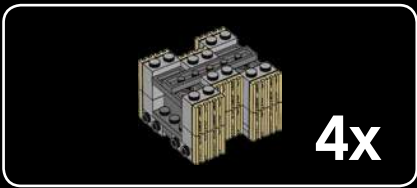

101

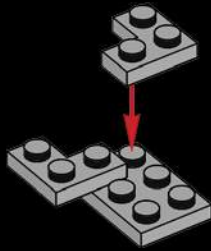

102

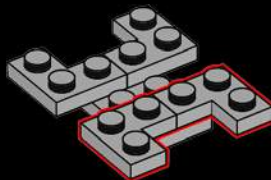

103

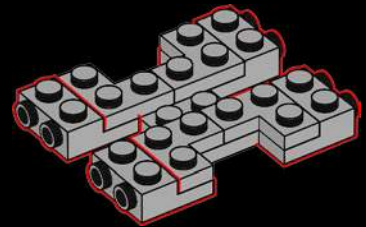



2x



1x

# 104

1

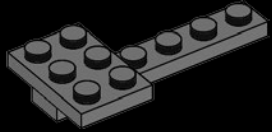

2

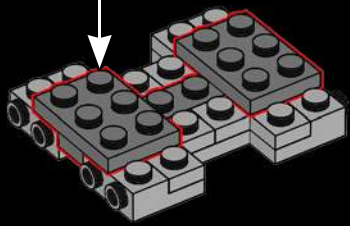
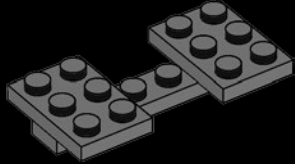

6x

# 105

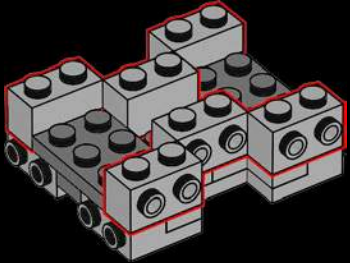

12x

# 106

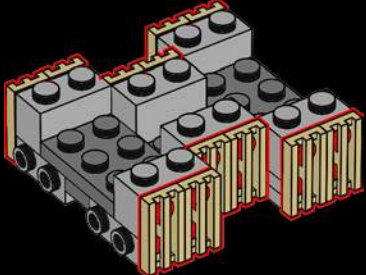

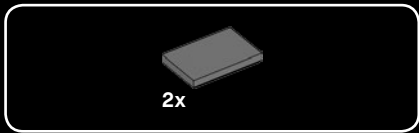

107

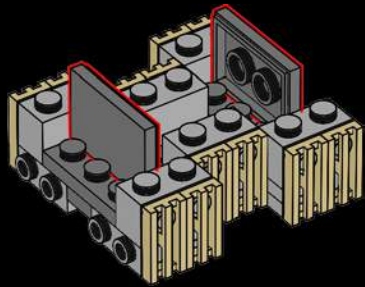

108

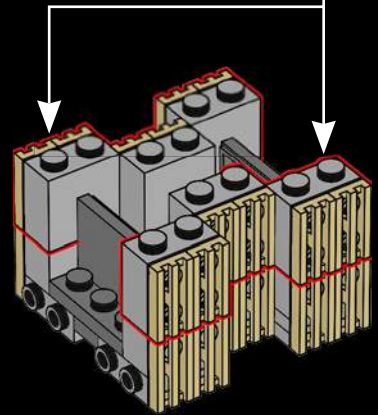
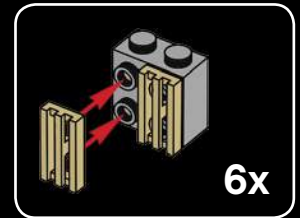

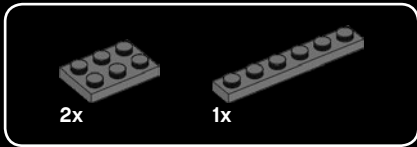

# 109

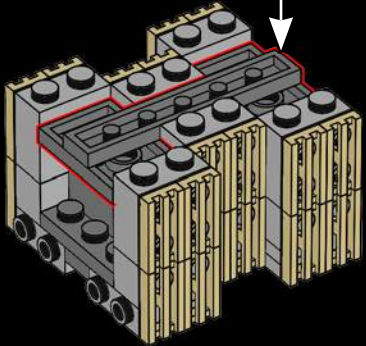
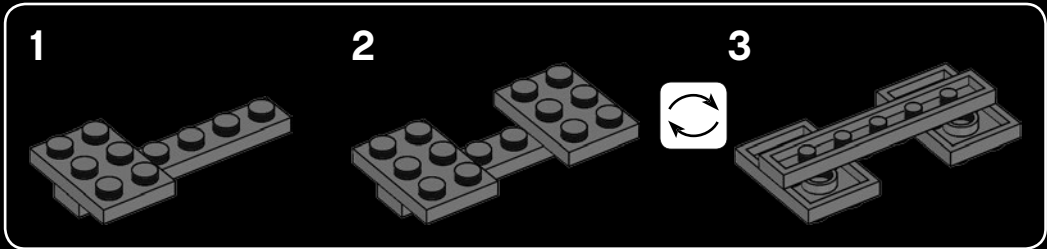

4x

110

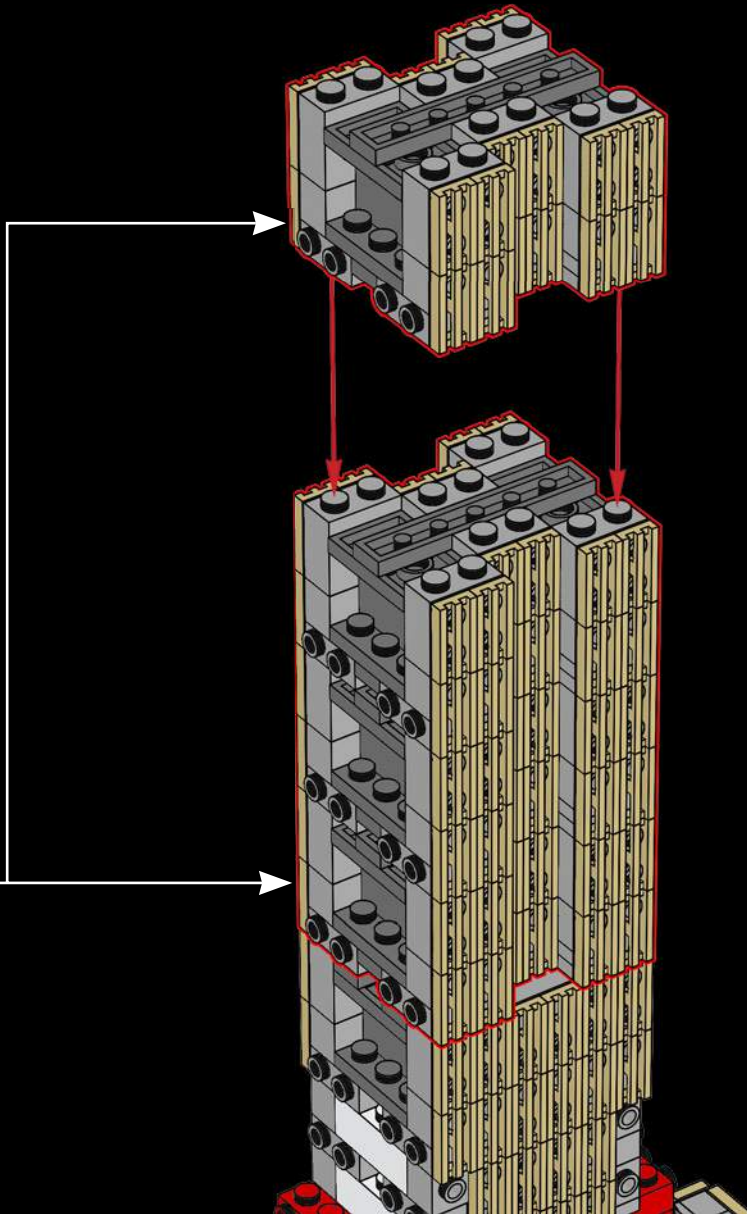

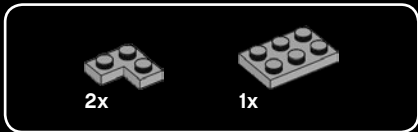
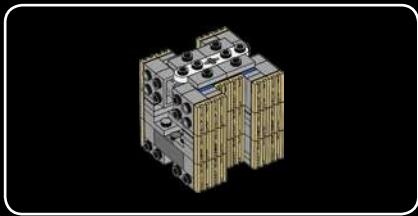

111

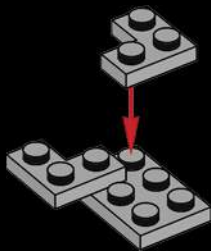

112

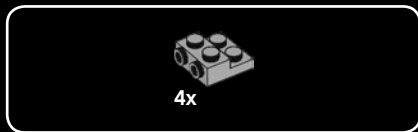
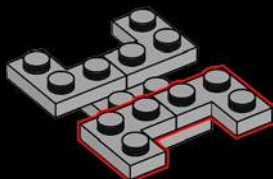

113

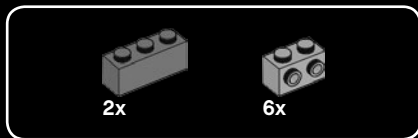
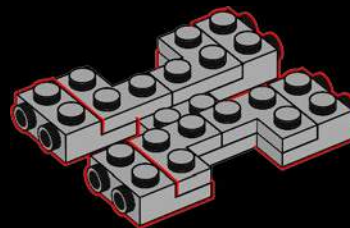

114

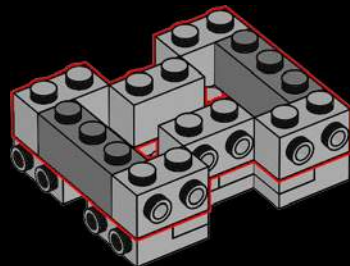

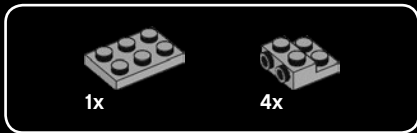

115

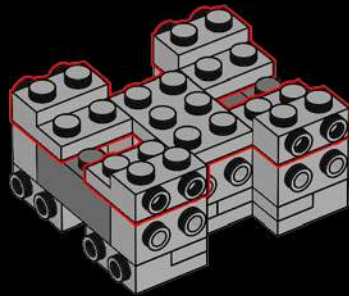

116

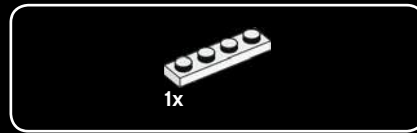
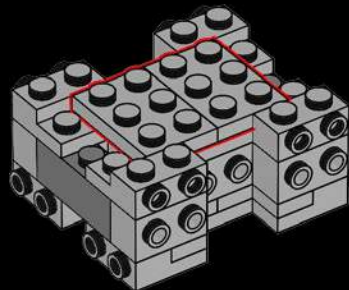

117

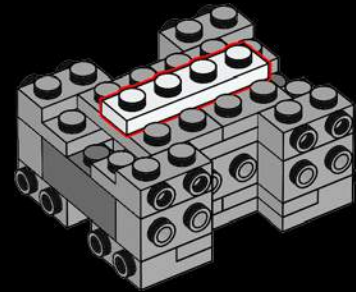

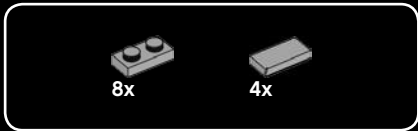

118

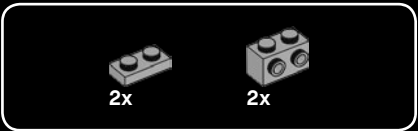
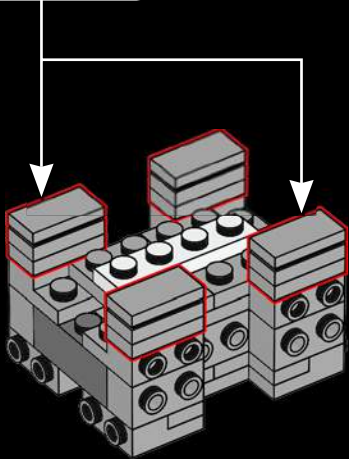
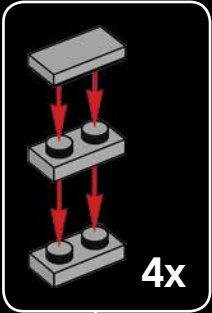

119

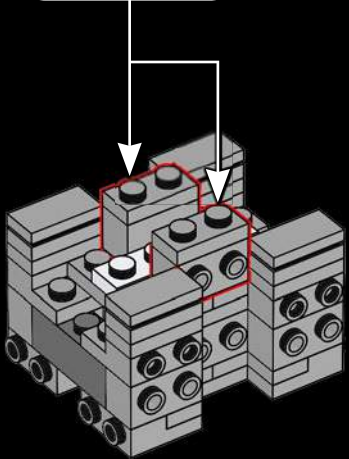
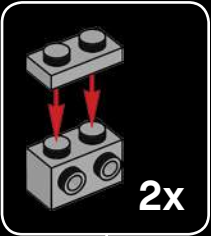

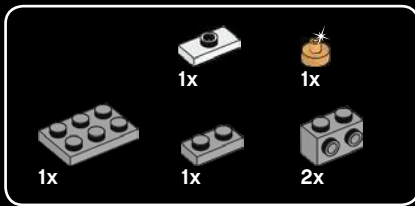

120

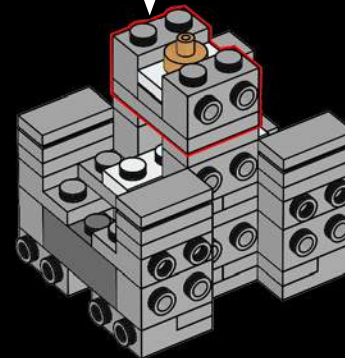
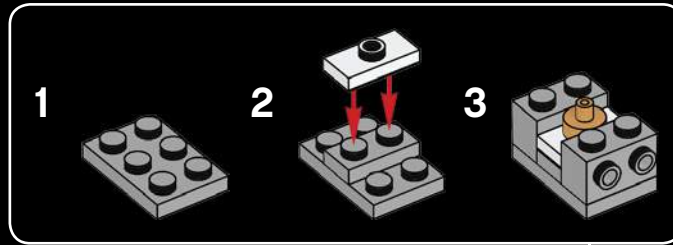



2x

121

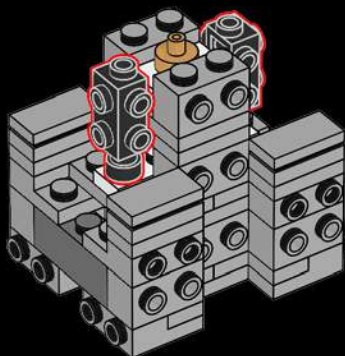

1x

122

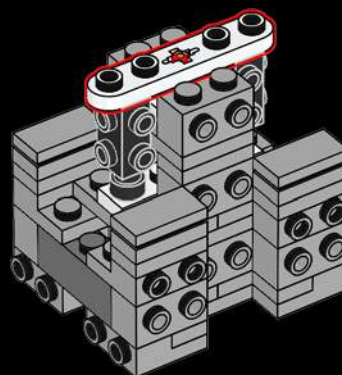

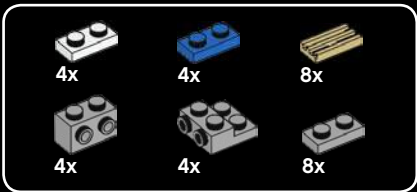

# 123

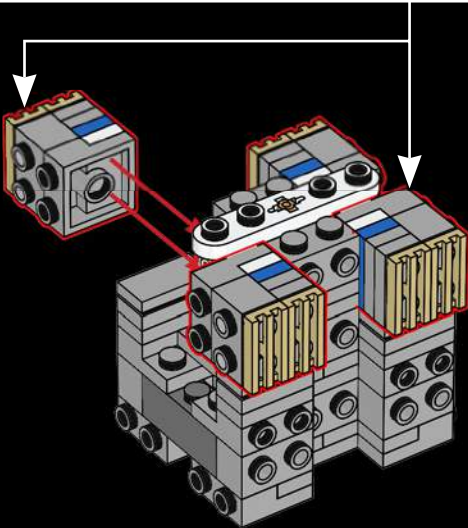
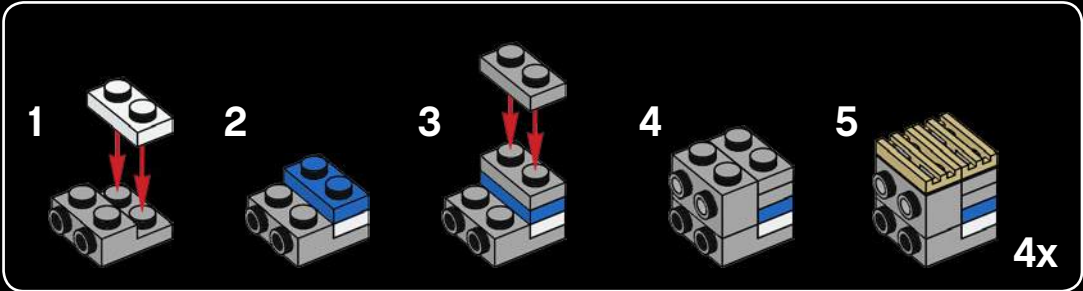



4x

# 124

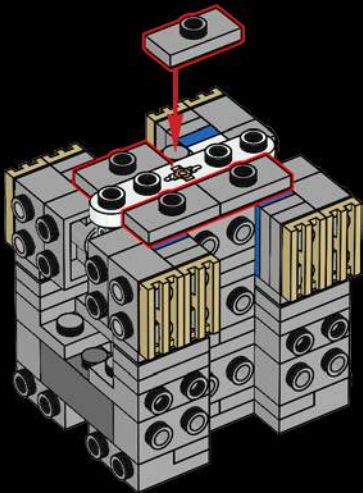

28x

# 125

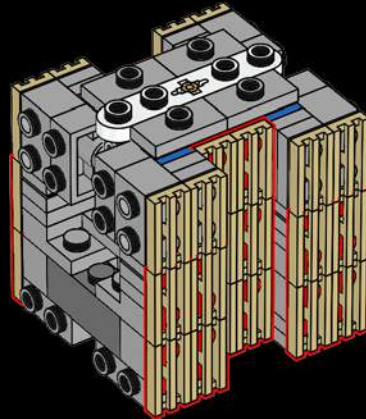

126

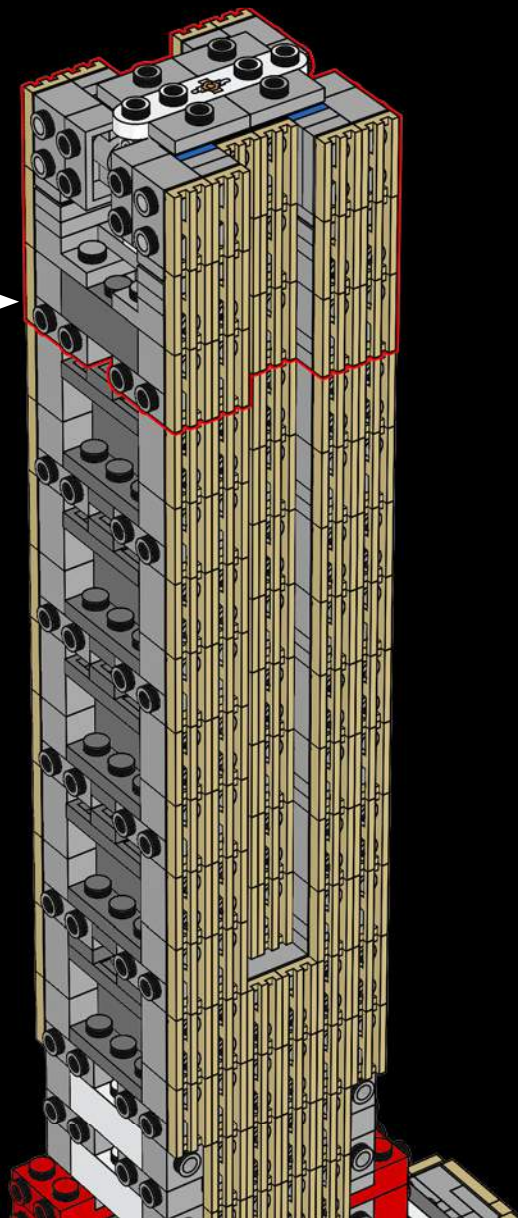



1x

1x

# 127

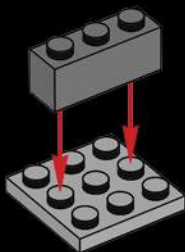

2x



2x

# 128

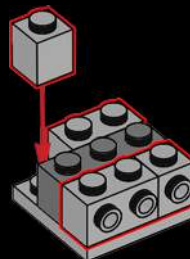

2x



1x

# 129

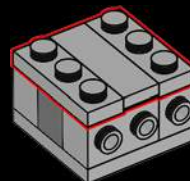



130

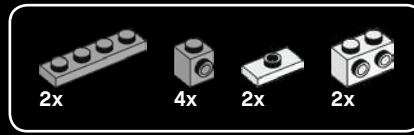
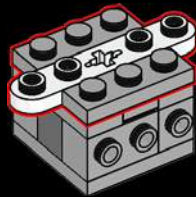

131

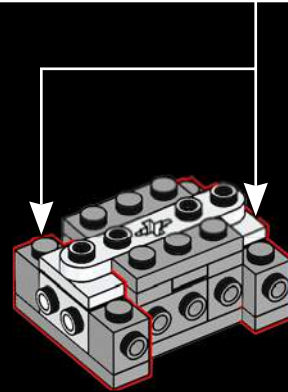
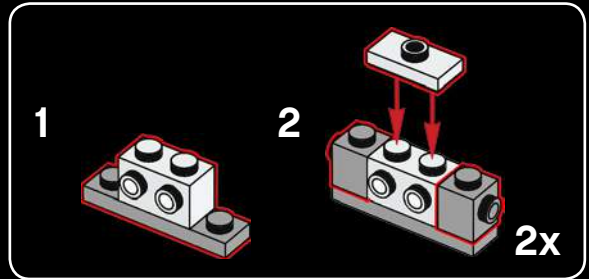



1x

# 132

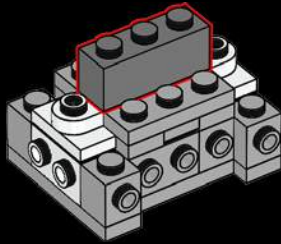

2x



2x

# 133

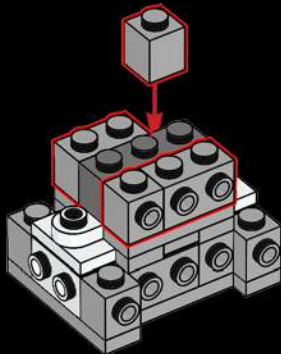

2x

# 134

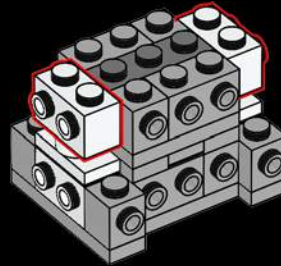



4x

# 135

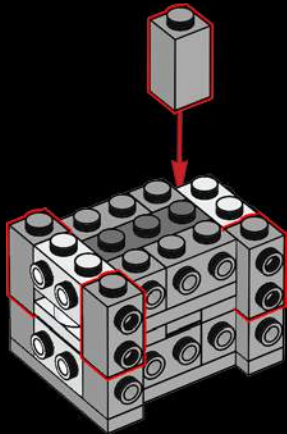

10x

# 136



137

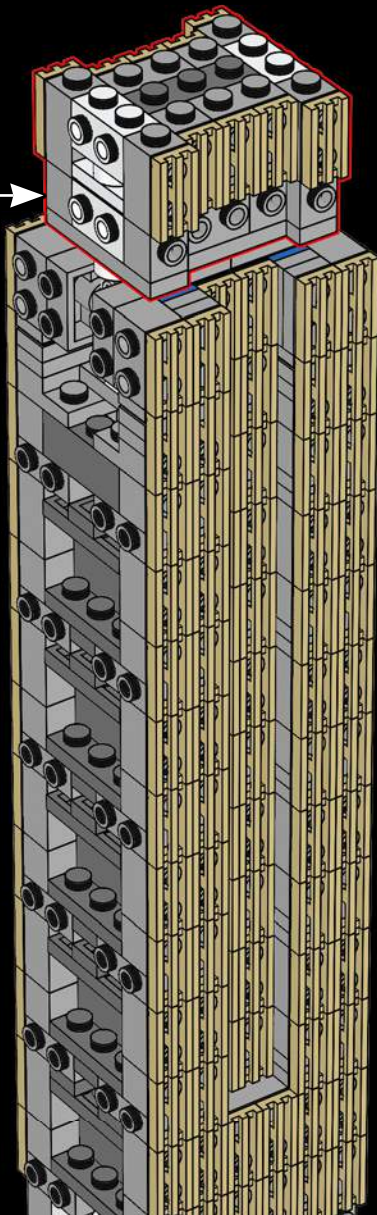



10x

138



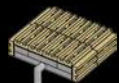

2x



1x



1x

# 139



2x

# 140

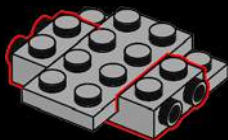

1x

# 141

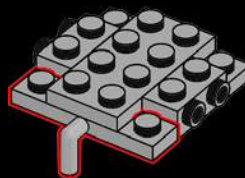



142

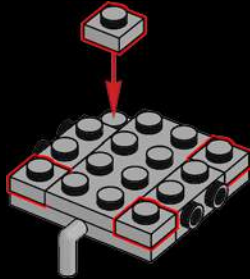

143

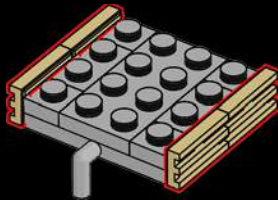

144

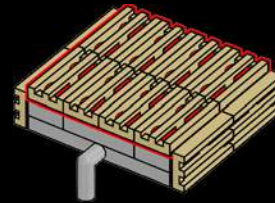

2x

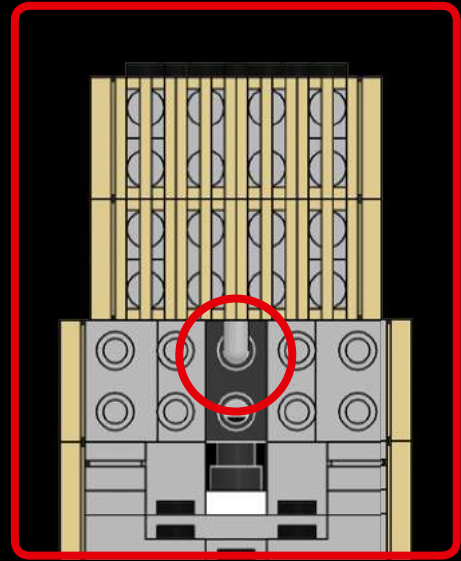
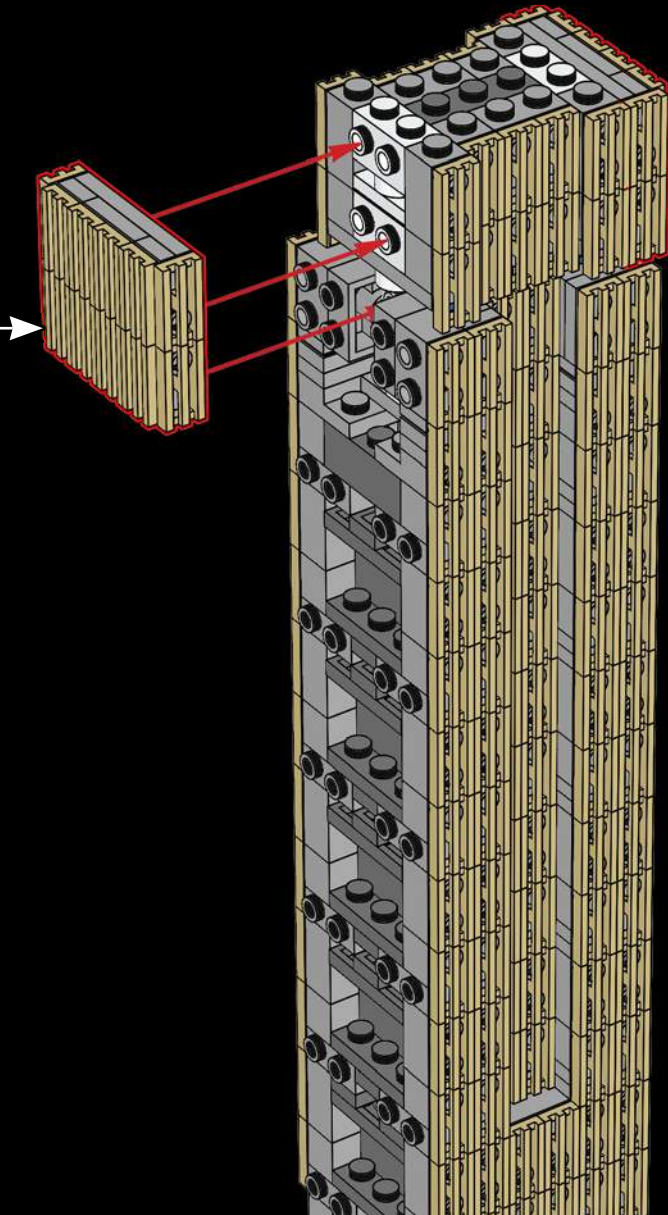

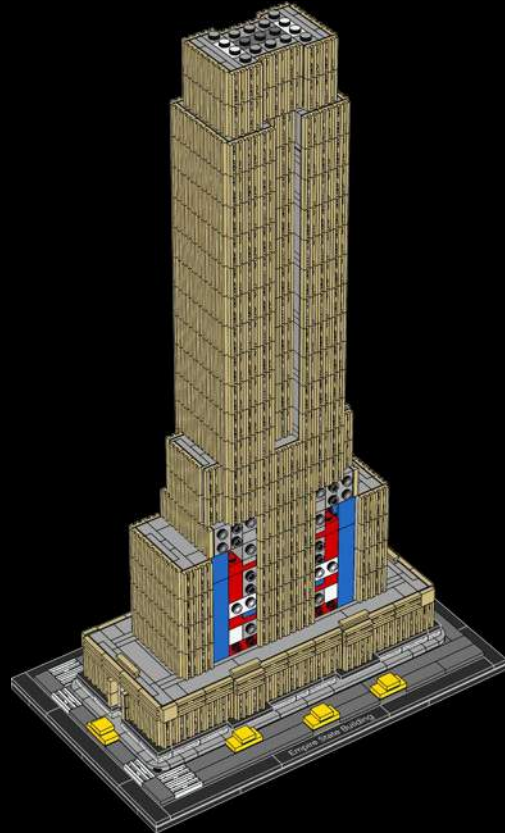
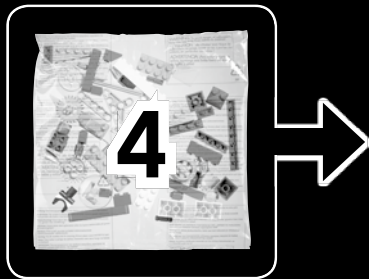



2x



1x

146



1x



1x

147



1x



4x

148

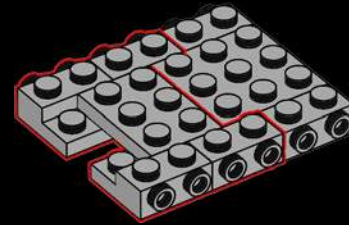

2x



1x

149

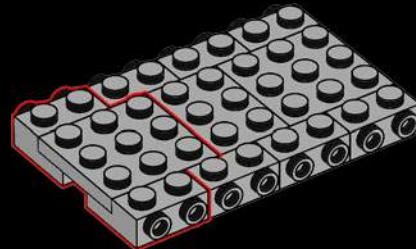

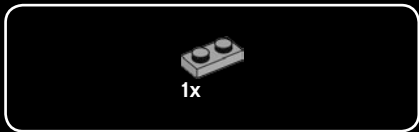

150

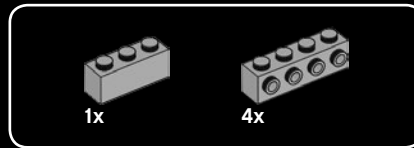
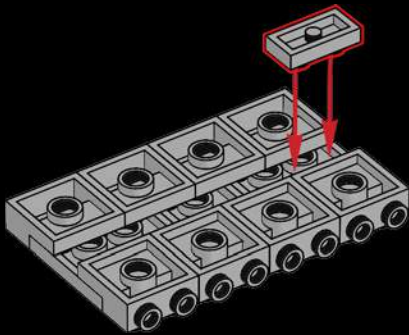

151

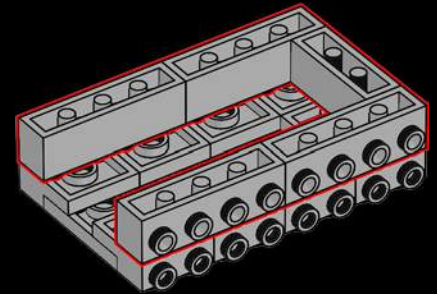

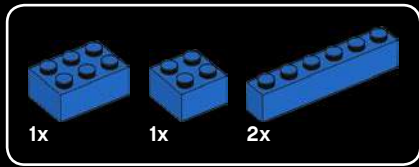

152

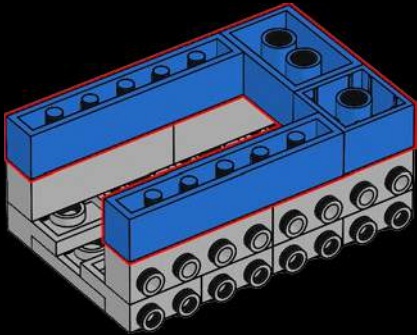

153

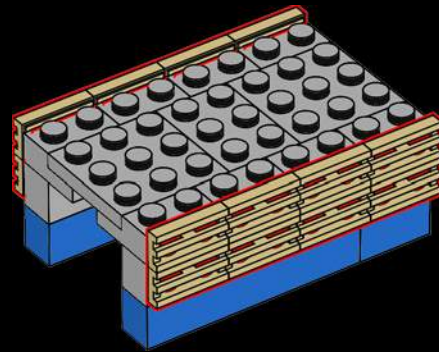



154

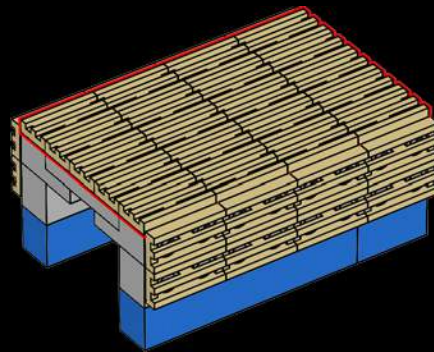

2x

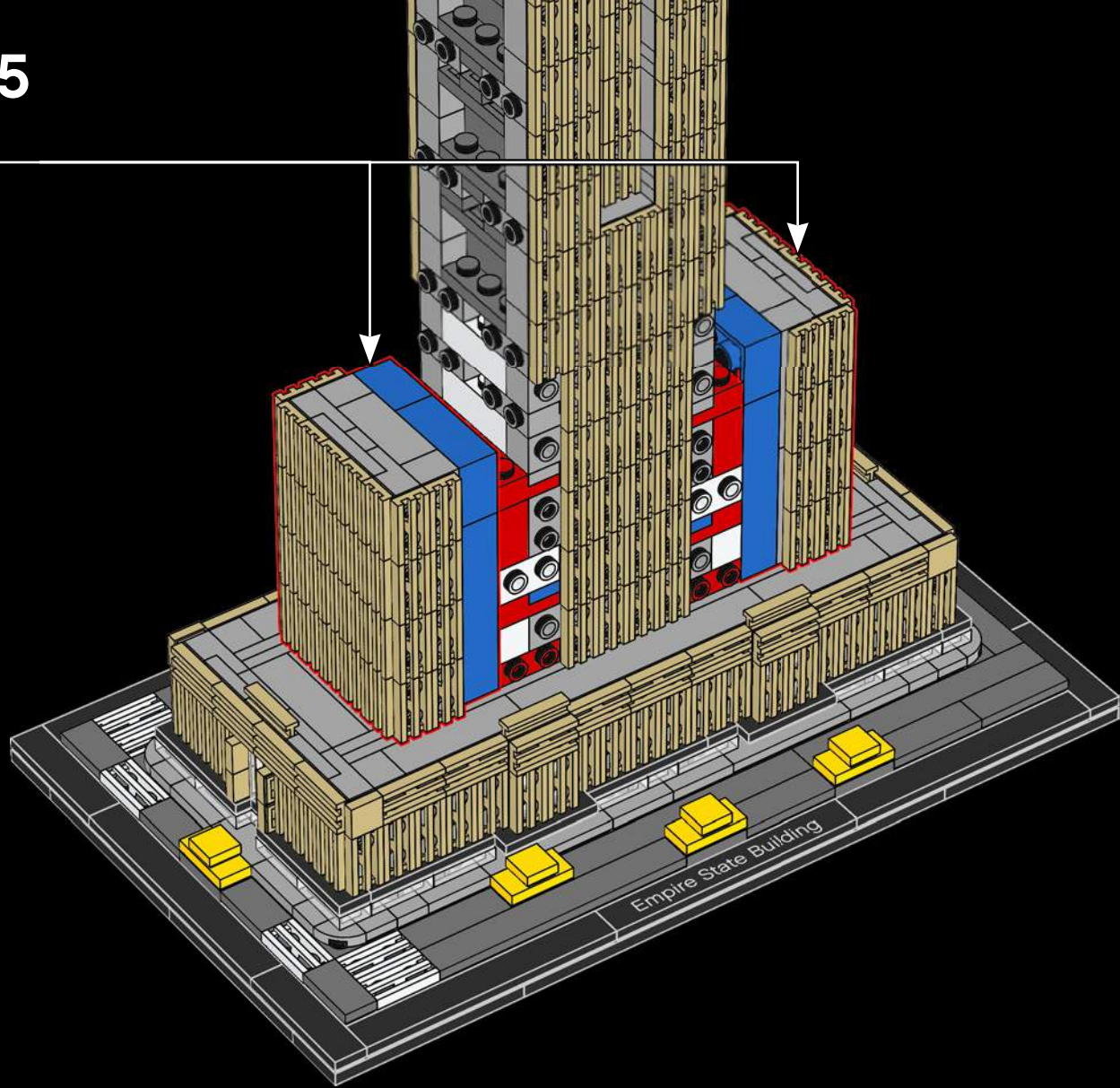

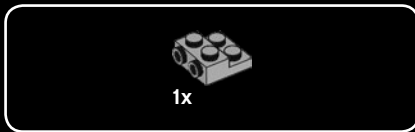
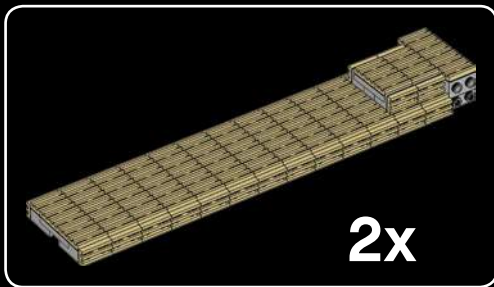

156

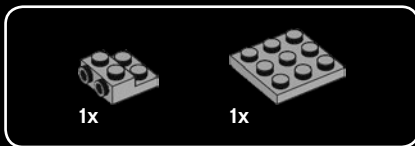

157



158

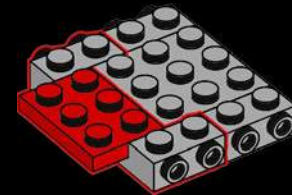

159

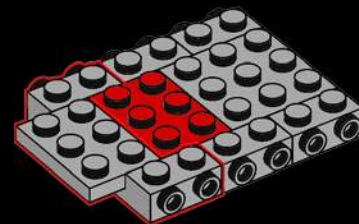

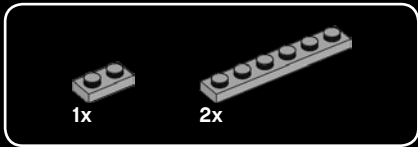

160

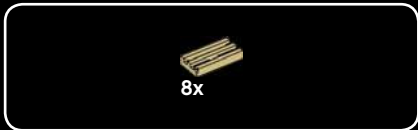
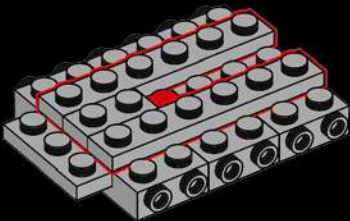

161

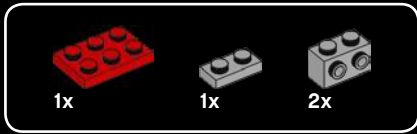
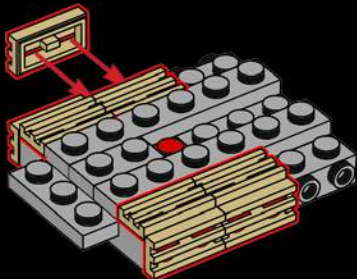

162

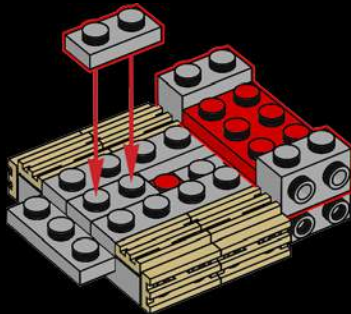

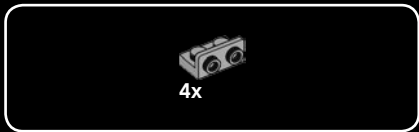

163

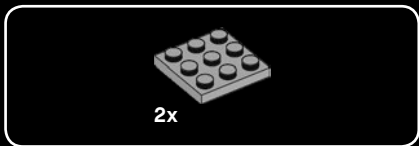
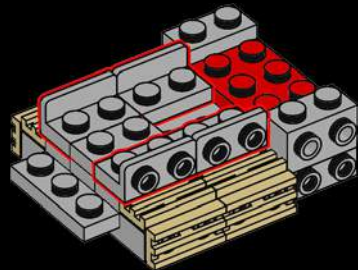

164

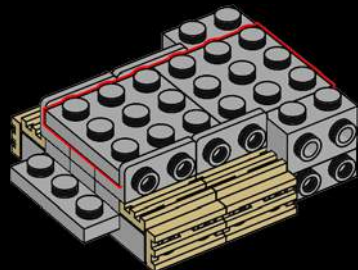

165

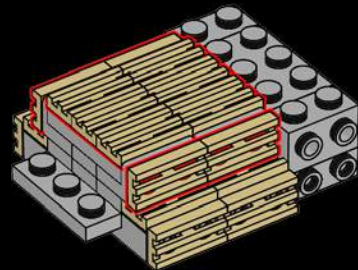

166

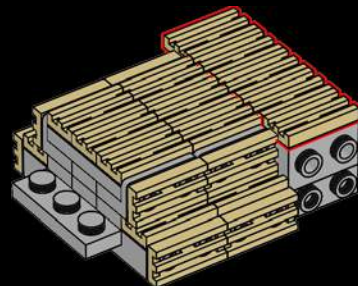

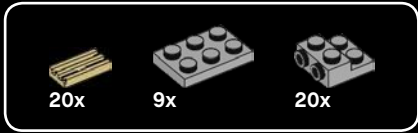

167

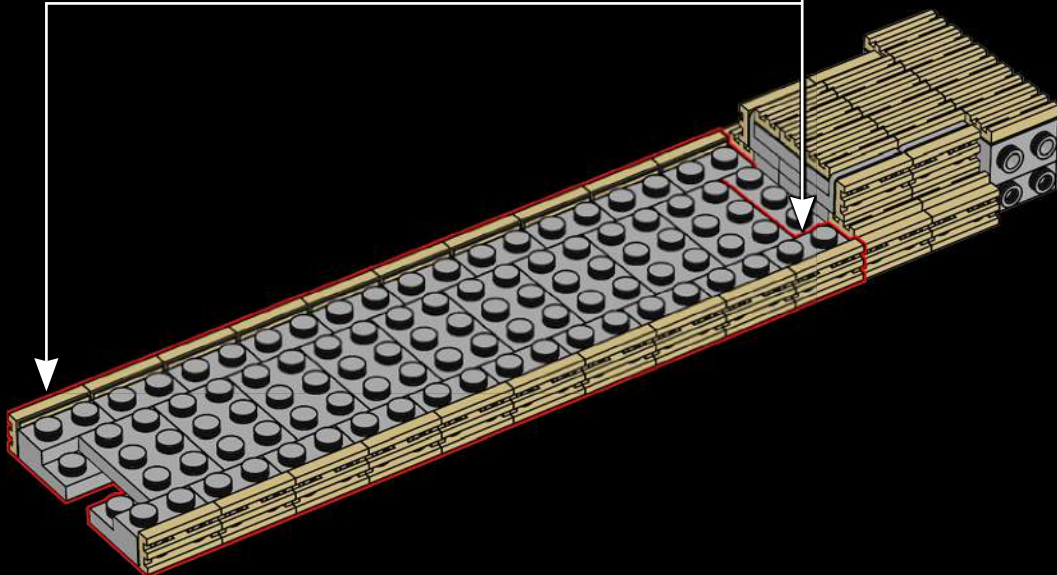
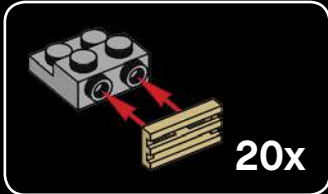

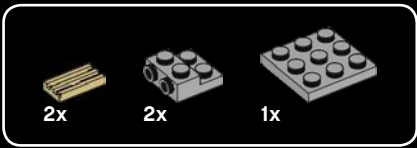

168

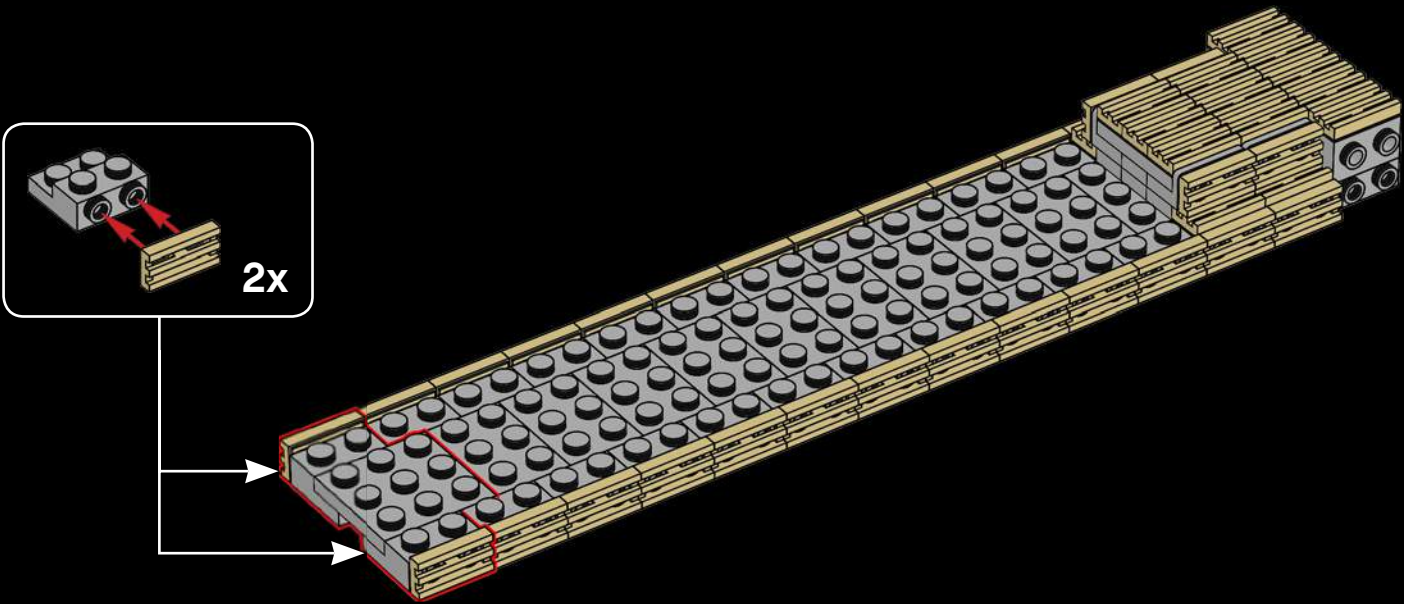



55x

169

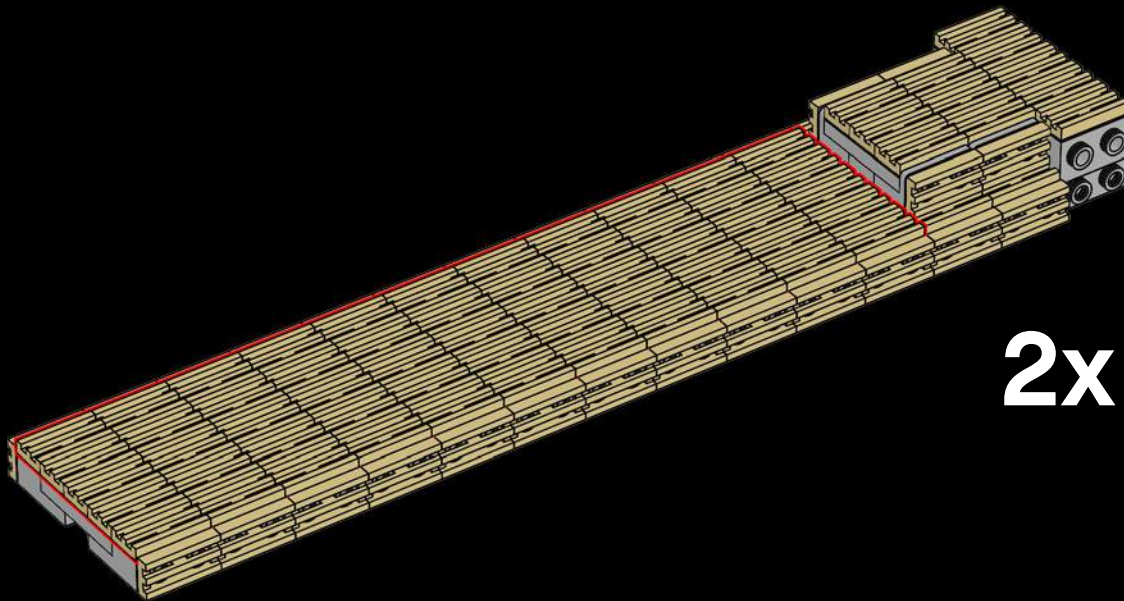

2x

170



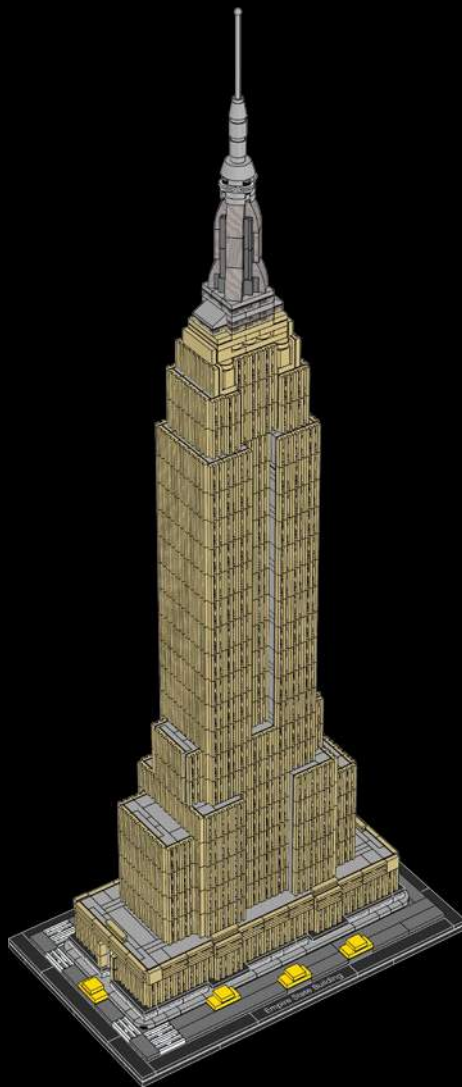

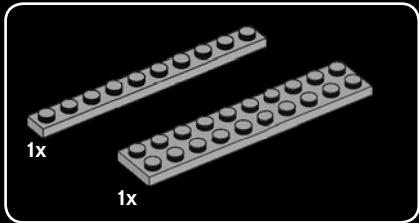
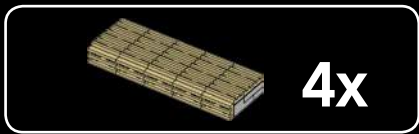

171

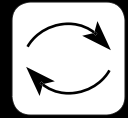
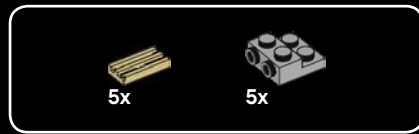
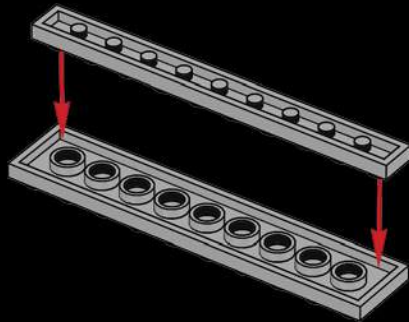

172

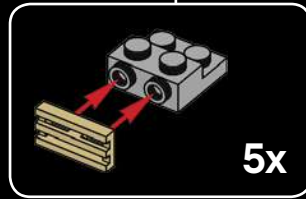
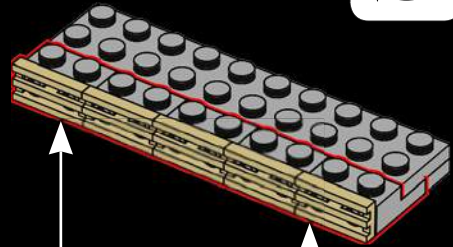

173

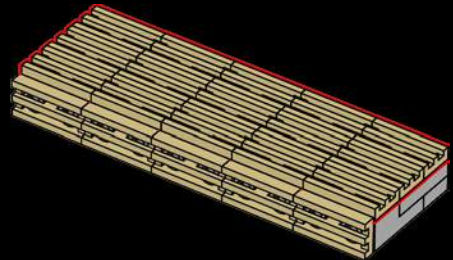

4x

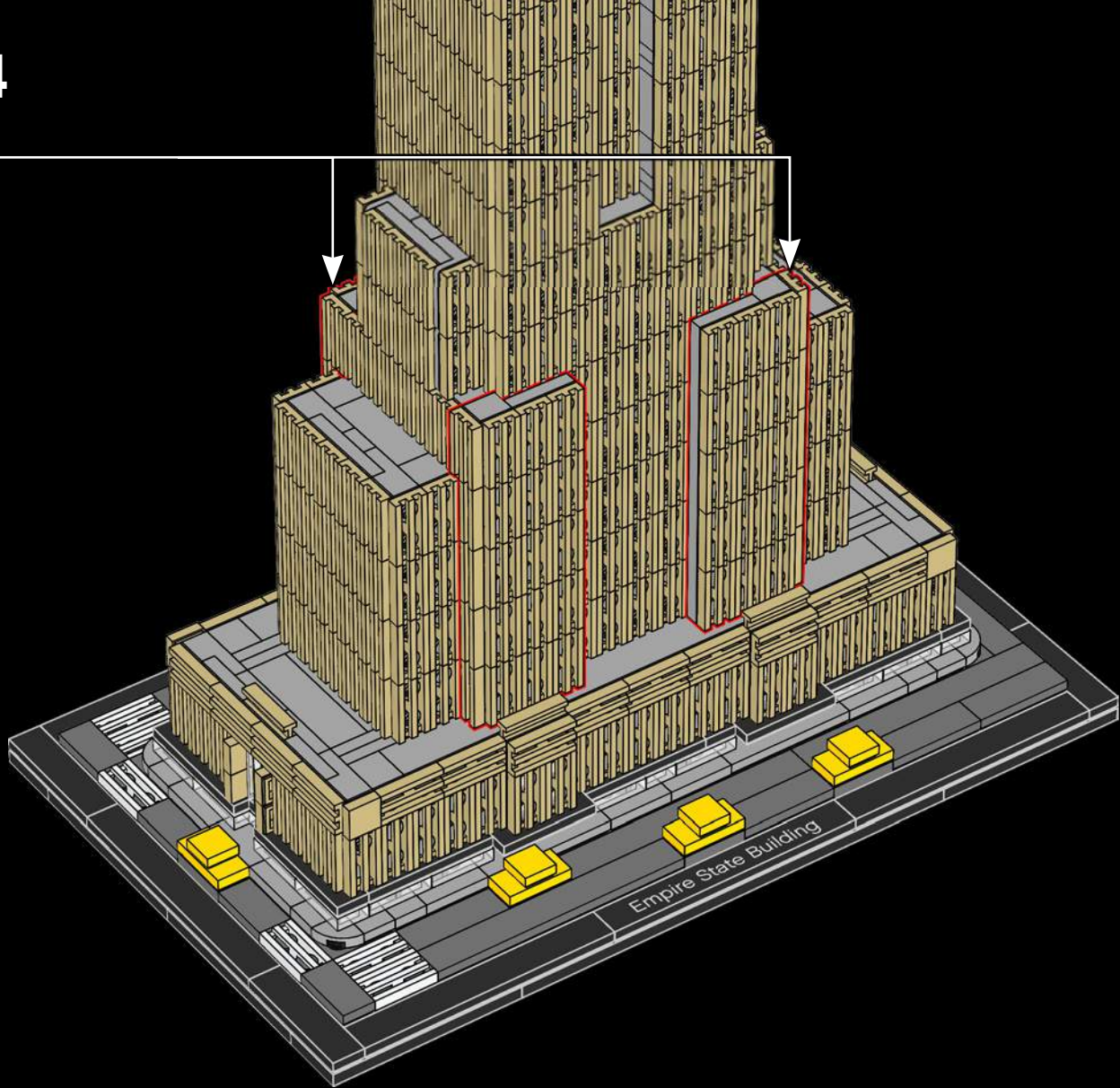





2x



2x

176

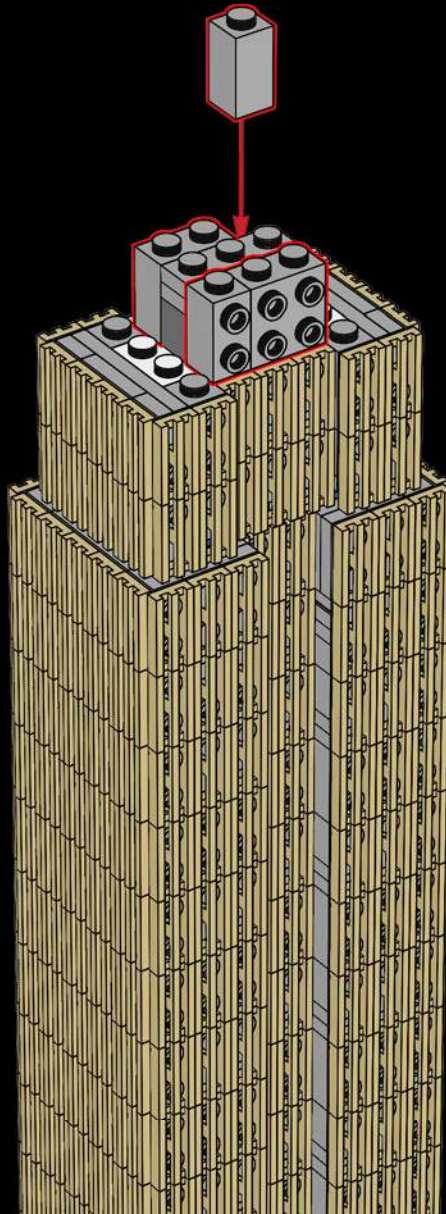



177

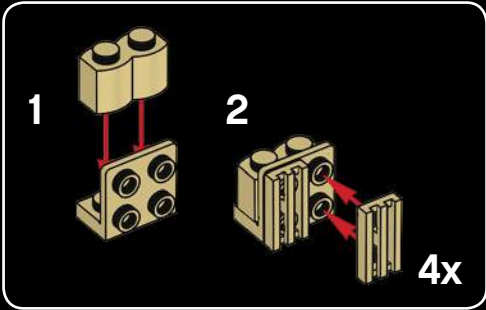

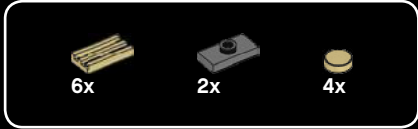

178

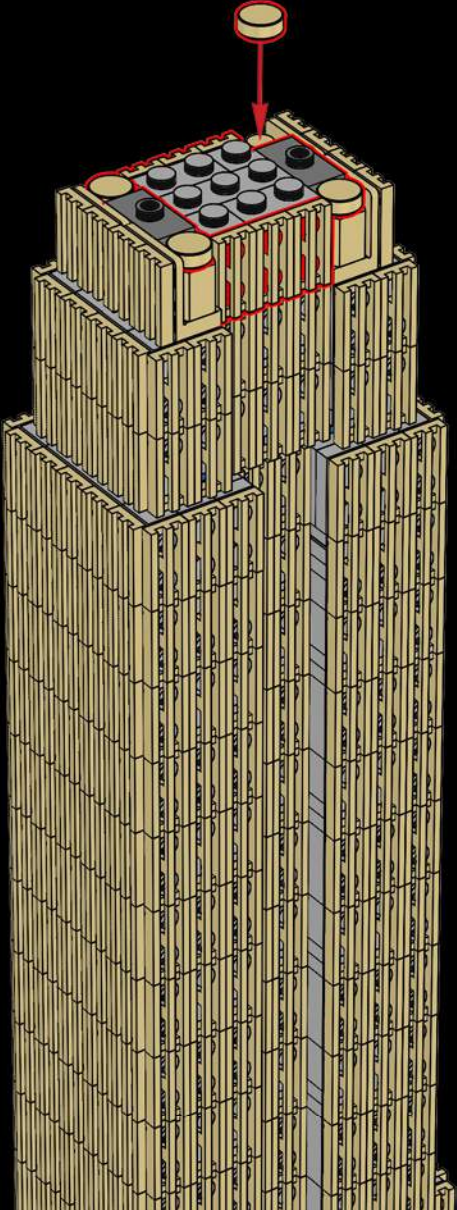



2x



1x

# 179

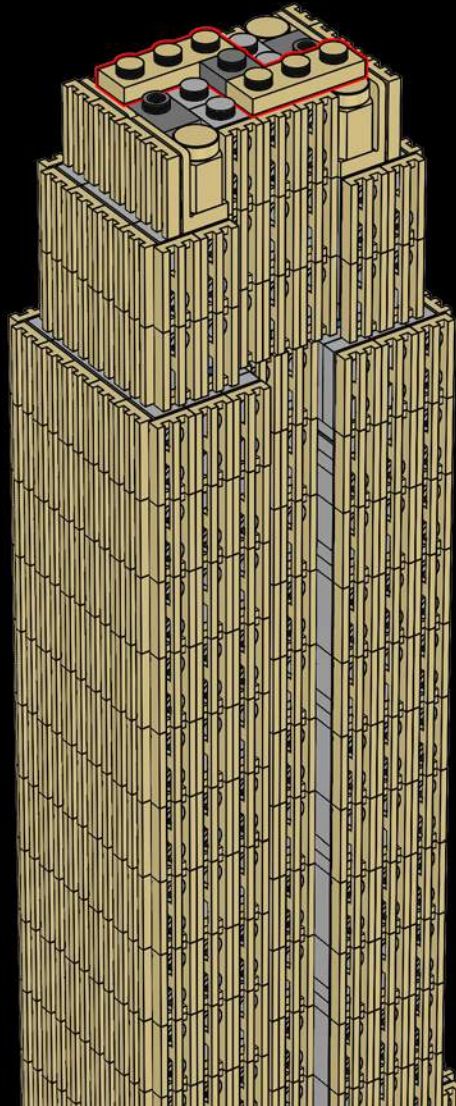



2x

180

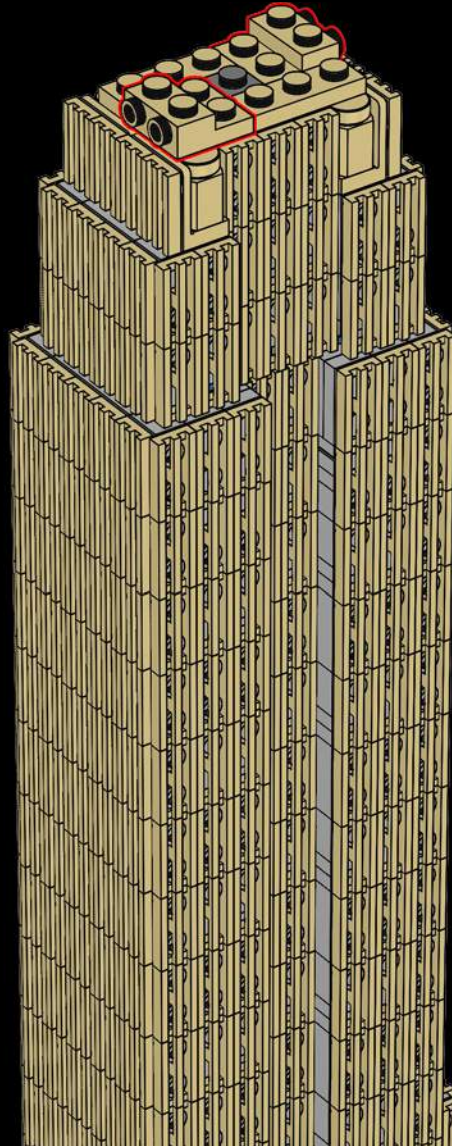

120

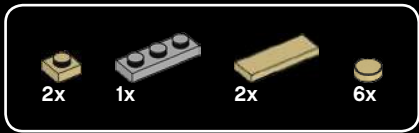

181

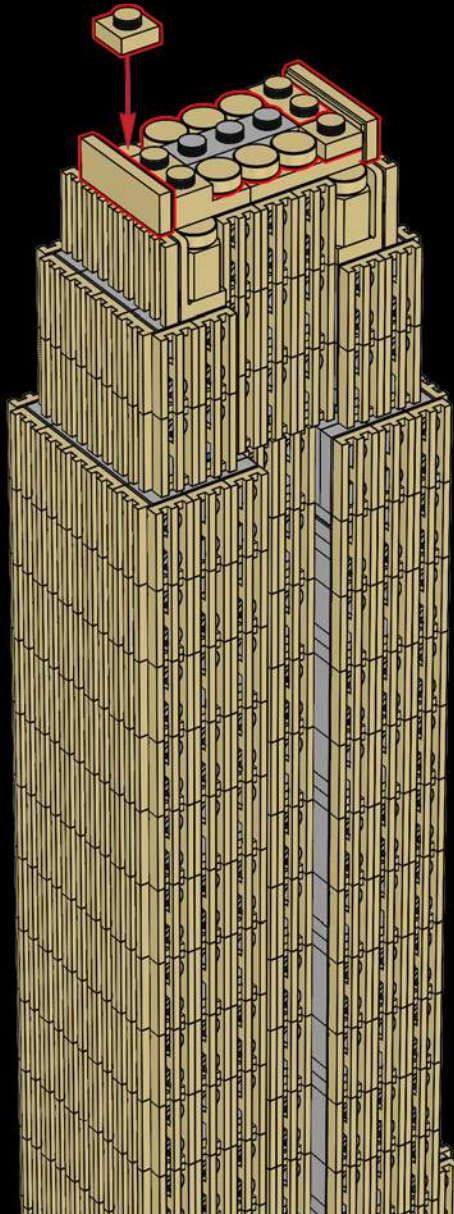

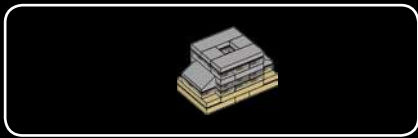

182

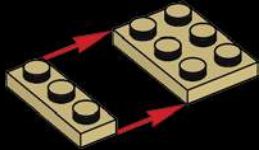

183

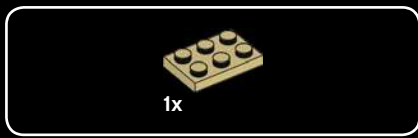
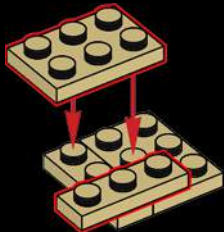

184

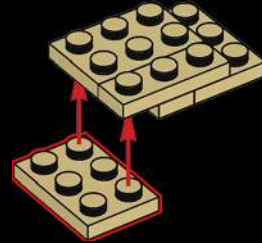

185

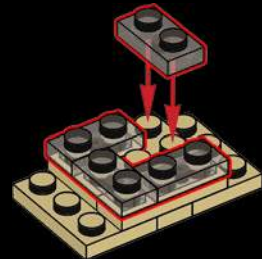



186

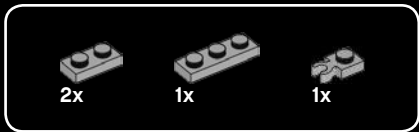
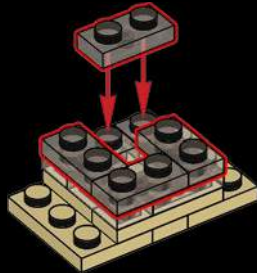

187

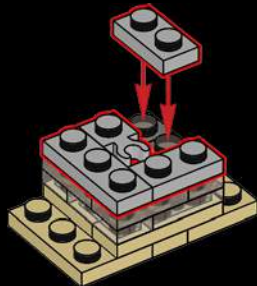

188

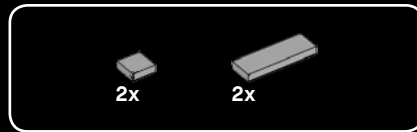
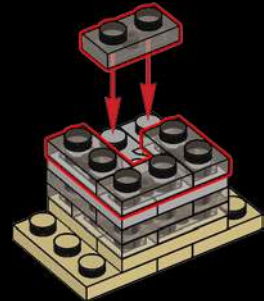

189

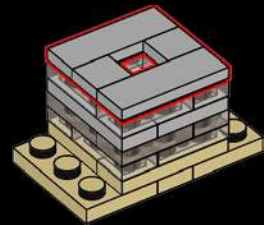

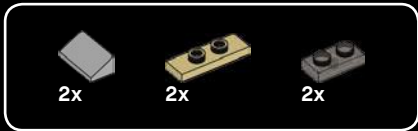

190

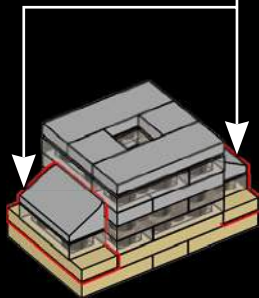
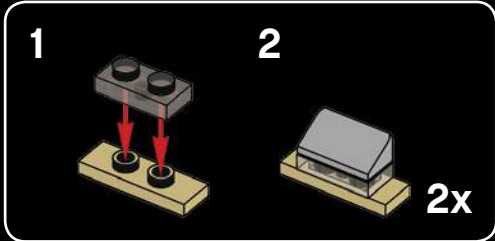

191





192

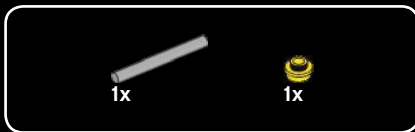
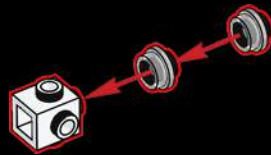

193

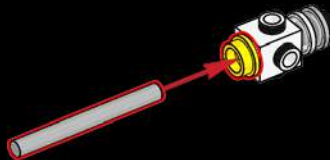

194

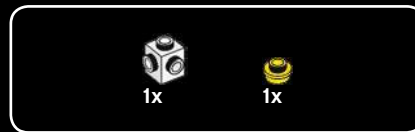
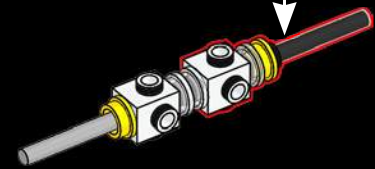
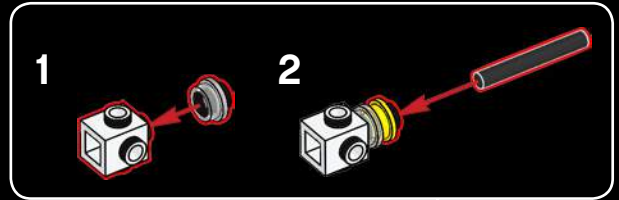

195

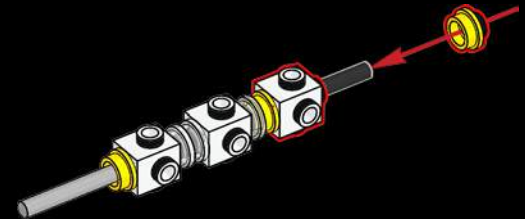



4x

# 196

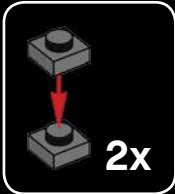

2x

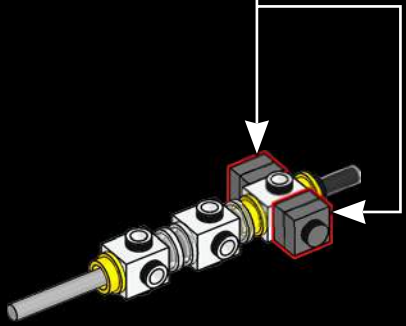

2x



2x



2x



4x



2x



4x

# 197

1

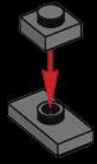

2

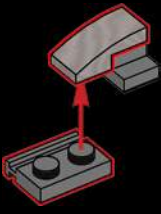

3

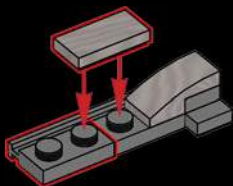

4

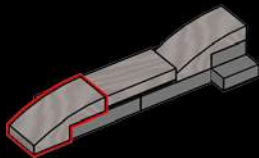

2x

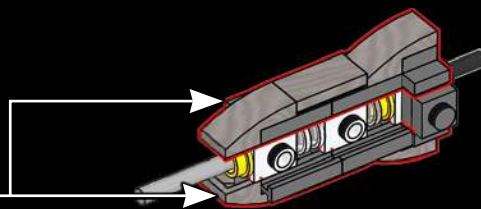



# 198

A 222 ft. (68 m) radio antenna was erected on top of the tower in 1950, allowing the area's television stations to broadcast from the building. Atop the tower is the 203 ft. (61.9 m) pinnacle, much of which is covered by broadcast antennas and surmounted with a lightning rod.

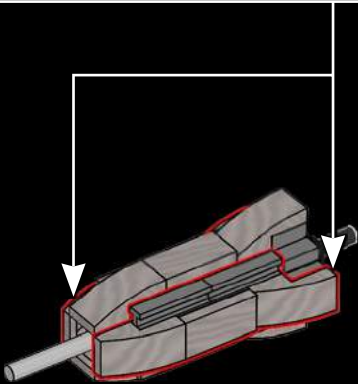
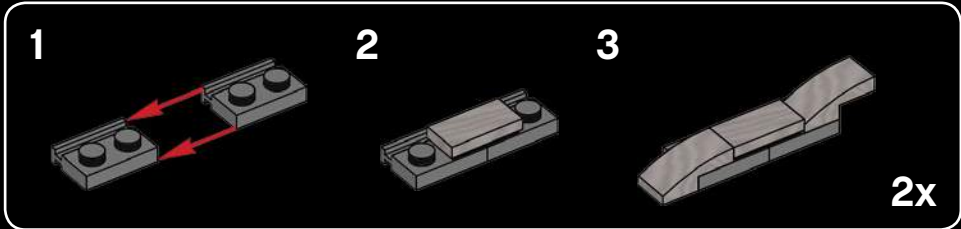



199

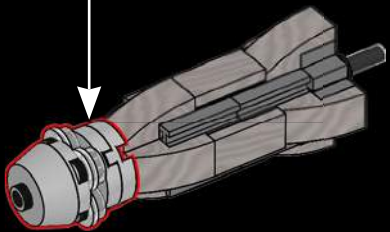
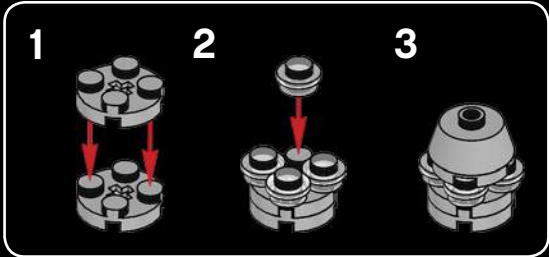

200

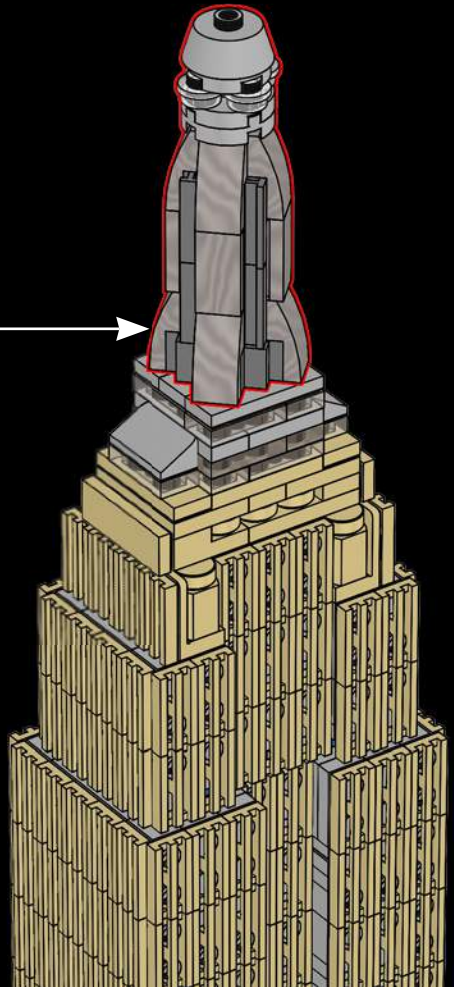

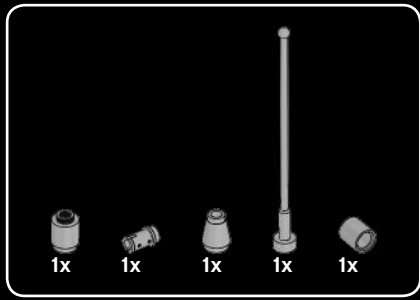

201

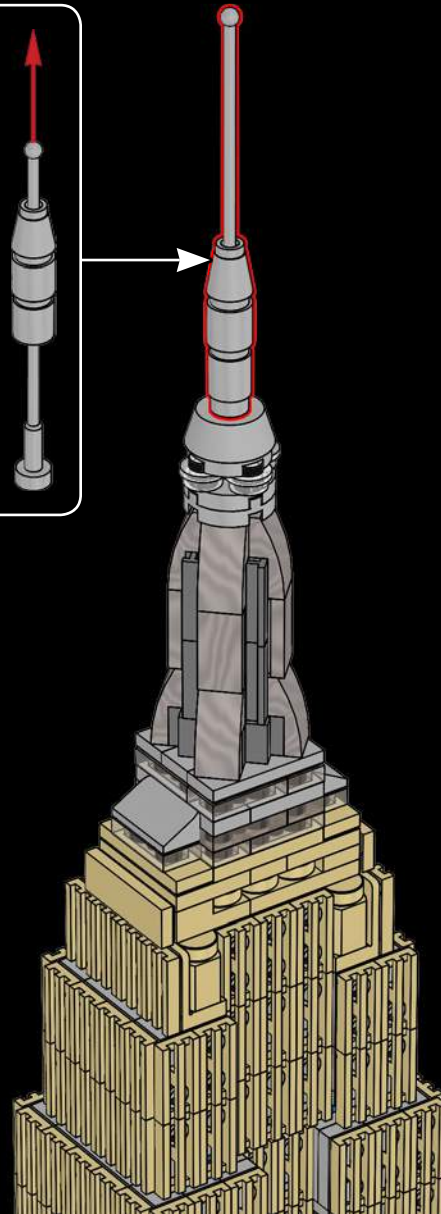
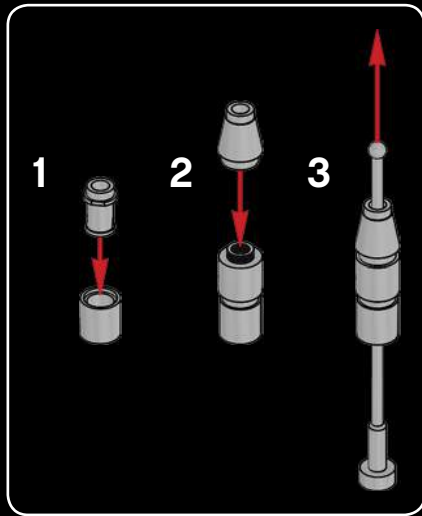

# LEGO® Architecture – do you like it?

The LEGO Group would like your opinion on the new product you have just purchased. Your feedback will help shape the future development of this product series. Please visit:

**[LEGO.com/productfeedback](https://www.lego.com/productfeedback)**

By completing our short feedback survey, you will be automatically entered into a drawing to win a LEGO® prize.





Terms & Conditions apply.

## LEGO® Architecture

The LEGO® Architecture series creatively captures the essence of many of the world's most iconic landmarks while giving you an enjoyable and engaging LEGO building experience.

Whether your interest is in travel, design, history or architecture, these sets are a physical memento of a great trip abroad, a famous building you know well, or a city you still dream of visiting.

Every LEGO Architecture set is designed to be displayed. Much more than just a photo, building and displaying your model on your desk, in the bookcase or on the shelf, lets you be transported every time you admire the view.

Follow us on  

Adam Reed Tucker is the co-developer of the LEGO Architecture product line.



Celebrate the world of architecture  
and collect all the models



21045  
Trafalgar Square



21041  
Great Wall of China



21030  
United States Capitol Building

21042  
Statue of Liberty



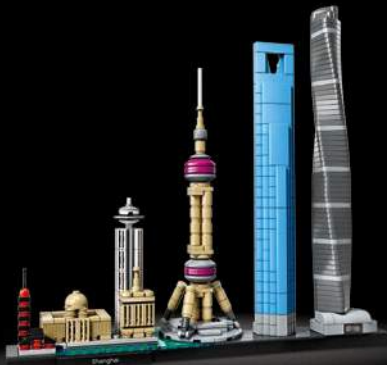

21039  
Shanghai



21034  
London



21047  
Las Vegas



21044  
Paris  
Paris



21028  
New York City



21043  
San Francisco

# References

*Pictures -*

© GettyImages

Customer Service  
Kundenservice  
Service Consommateurs  
Servicio Al Consumidor  
[LEGO.com/service](http://LEGO.com/service) or dial

 00800 5346 5555 ;  
 1-800-422-5346 ;

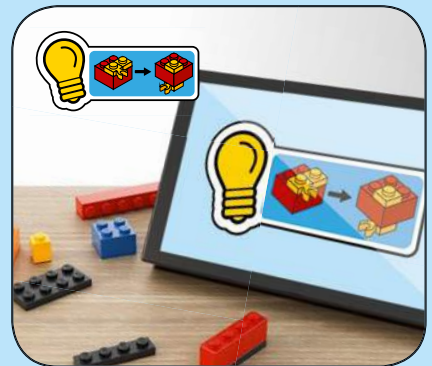



3x  
4111971



2x  
4547489



12x  
6058177



6x  
241201



11x  
6051511



4x  
302301



6x  
6018774



6x  
6097637



4x  
362201



19x  
302101



1x  
300201



1x  
371001

138



2x  
4527839



2x  
302001



4x  
4560178



2x  
346001



10x  
6139649



4x  
4125253



2x  
4159553



4x  
4218749



684x  
4124456



4x  
6174925



6x  
4160483



2x  
6132769



4x  
4121921



2x  
6131896



10x  
6211966



3x  
4118790



2x  
4201062



4x  
4124067



4x  
6187620



4x  
4569056



4x  
6135130



20x  
6061711



4x  
302121



2x  
371021



4x  
6217123



2x  
346021



14x  
302323



2x  
300323



8x  
300223



8x  
300923



3x  
6168644



6x  
307024



2x  
300424



6x  
6092583



4x  
307026



8x  
302426



1x  
6093525



4x  
242026



2x  
4523339



4x  
6162892



16x  
243126



8x  
379526



7x  
416226



1x  
6265011



4x  
4100378



2x  
6001494



7x  
6240030



8x  
6252041



32x  
6240204



8x  
6251294

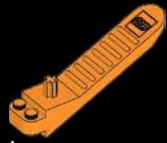

1x  
6240515



14x  
6240219



1x  
6164381



1x  
4211412



1x  
4529241



1x  
6183784



1x  
4211483



4x  
6176433



16x  
4211399



8x  
4558953



6x  
4211415

**6x**  
6225242

**1x**  
4594238

**2x**  
4211475

**1x**  
6028324

**2x**  
4568637

**22x**  
6066097

**31x**  
4211398

**10x**  
4211414

**72x**  
6015344

**42x**  
6123809

**8x**  
6004990

**12x**  
6126082

**32x**  
4211353

**2x**  
4237084

**148x**  
4654577

**16x**  
4211429

**2x**  
4211428

**3x**  
4558169

**1x**  
6116608

**39x**  
4211396

**4x**  
4211356

**8x**  
4211636

**2x**  
4211394

**2x**  
6173095

**6x**  
4211445

**19x**  
6015347

**2x**  
4211395

**4x**  
4211385

**6x**  
4211393

**6x**  
4211549

**12x**  
4211438

**2x**  
6037399

**2x**  
4211474

**4x**  
4251149

**4x**  
4211462

**7x**  
4210719

**5x**  
4211052

**6x**  
4211063

**4x**  
6092572

**8x**  
4543086

**5x**  
4211104

**6x**  
4568734

**14x**  
6187008

**29x**  
4211043

**12x**  
4211056

**4x**  
4211002

**8x**  
4211008

**4x**  
4210998

**6x**  
4210997

**6x**  
4211122

**1x**  
6186672

**4x**  
6107197

**4x**  
6217492

**8x**  
6092115

**8x**  
6066028

**Customer Service**  
**Kundenservice**  
**Service Consommateurs**  
**Servicio Al Consumidor**

**LEGO.com/service or dial**

 : 00800 5346 5555  
: 1-800-422-5346



LEGO and the LEGO logo are trademarks of the LEGO Group.  
©2019 The LEGO Group. 6281924

The Empire State Building name and images® are registered trademarks of ESRT Empire State Building, L.L.C and are used with permission.

 [LEGO.com/architecture](https://www.lego.com/architecture)

Follow LEGO® Architecture on

