

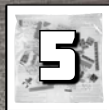

CITY

60216

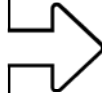

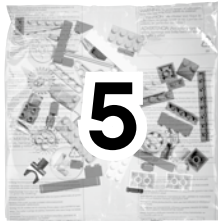
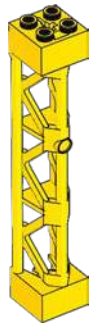
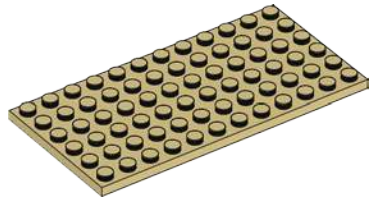

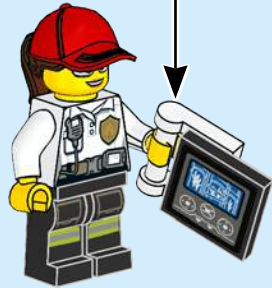
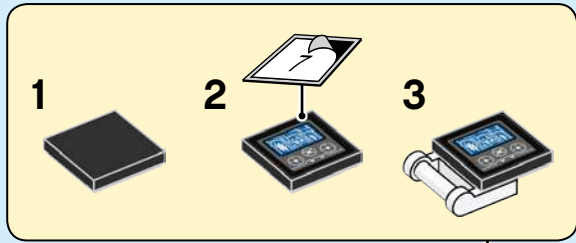
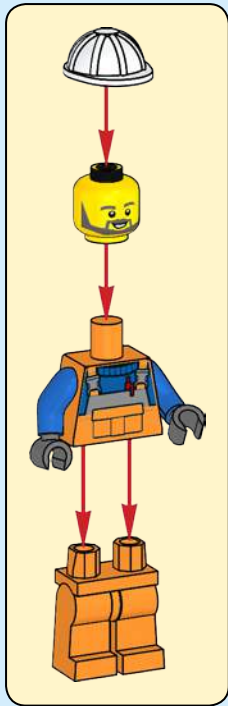

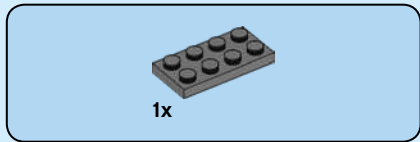
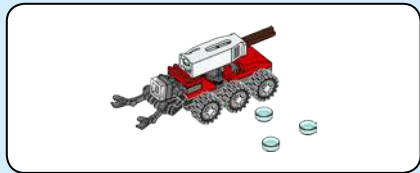

1

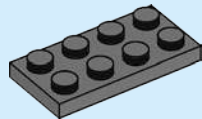



1x

2

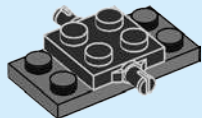

2x

3

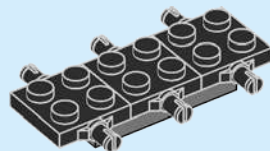

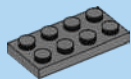

1x

4

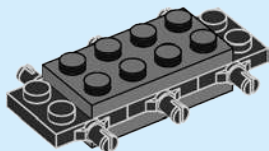

6



1x



1x

5

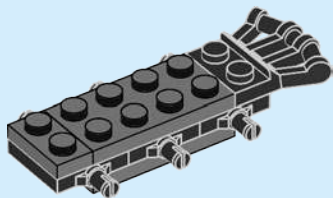

2x

6

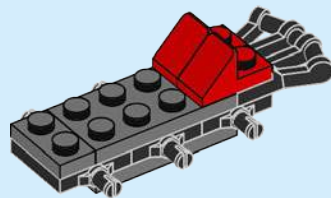



1x

7

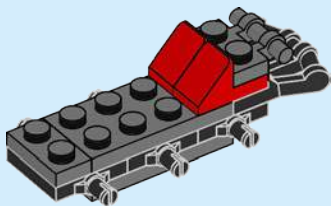

8



1x

8

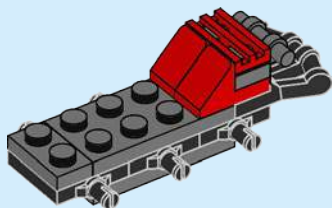

2x

9

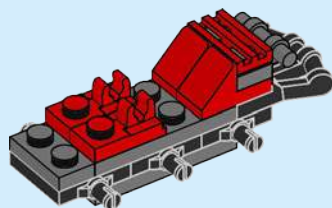



1x

10

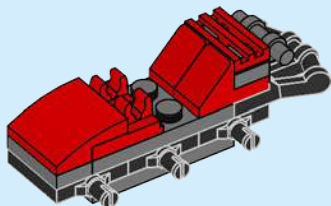



1x

11

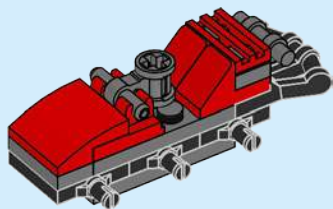

2x

12

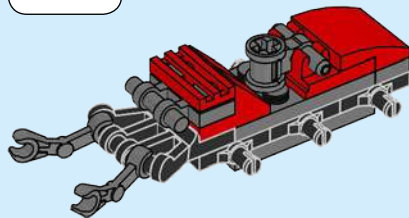
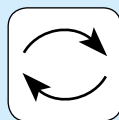



1x



1x

13

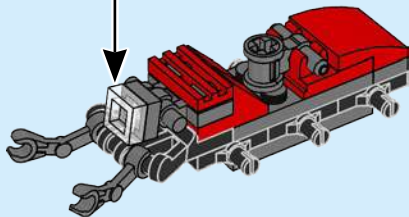
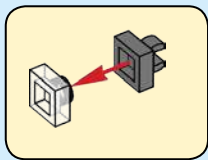



6x



6x

14

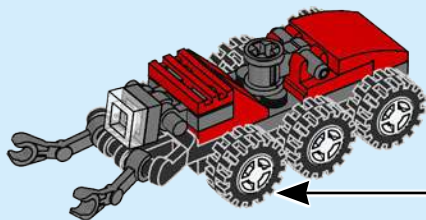

6x

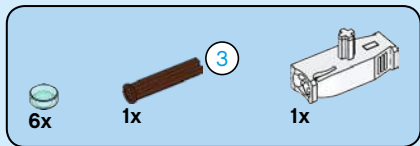
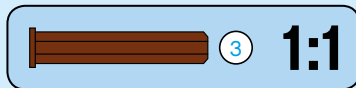
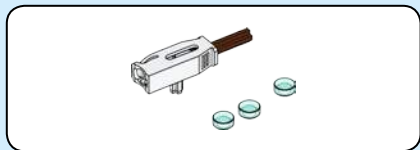

15

1

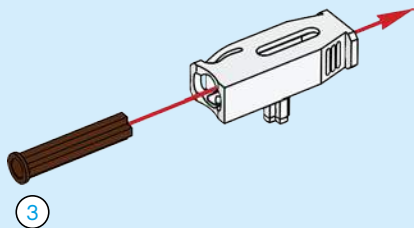

2

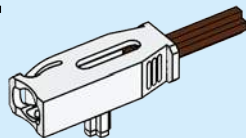

3

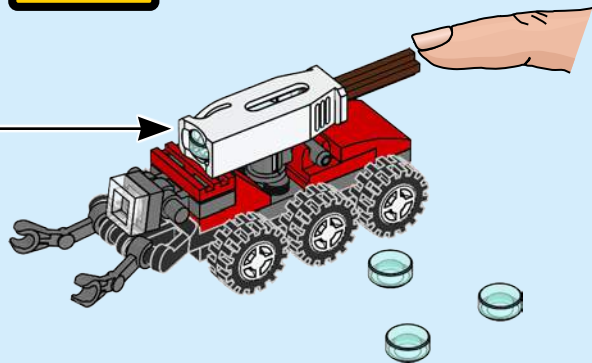
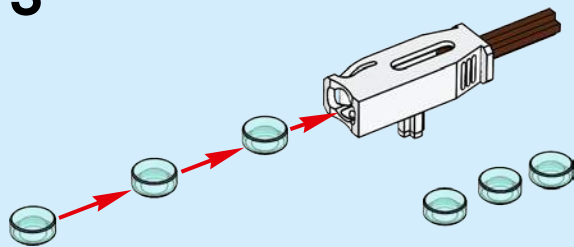

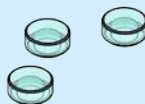
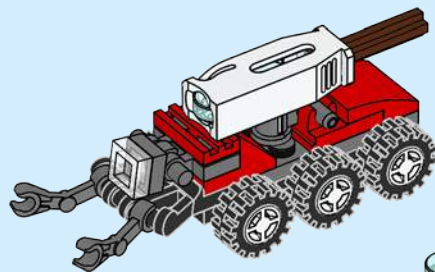
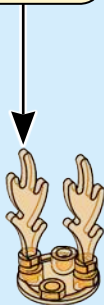
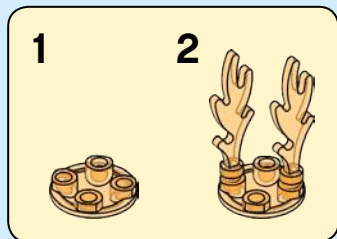

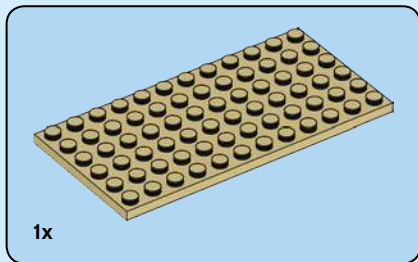

1

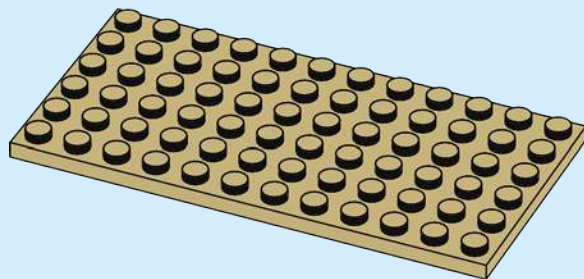

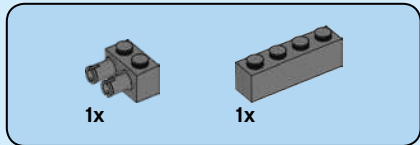

2

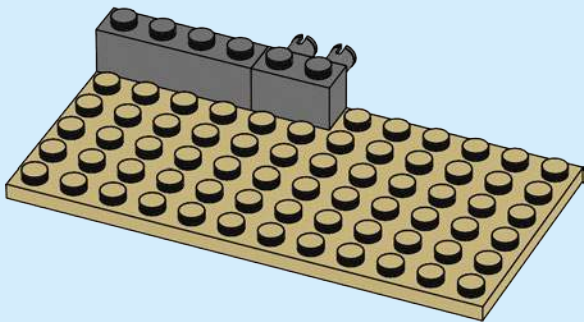

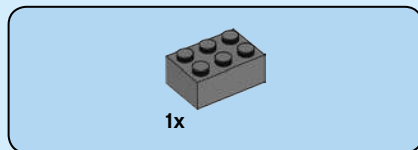

3

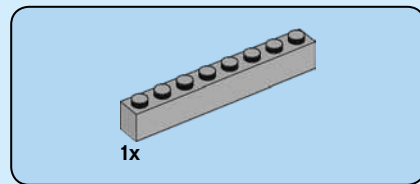
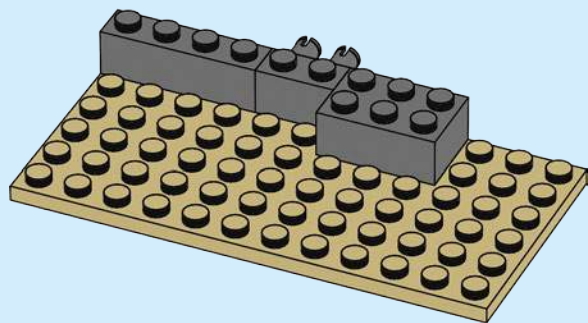

4

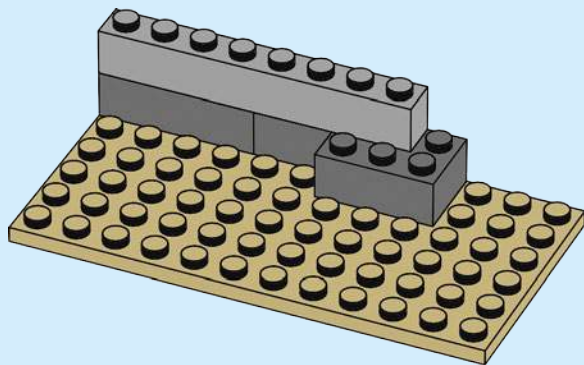

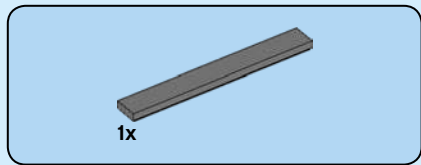

5

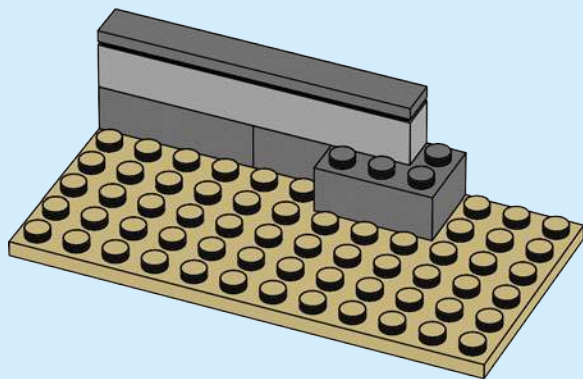

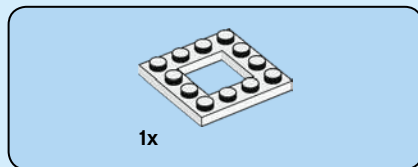

6

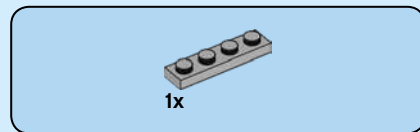
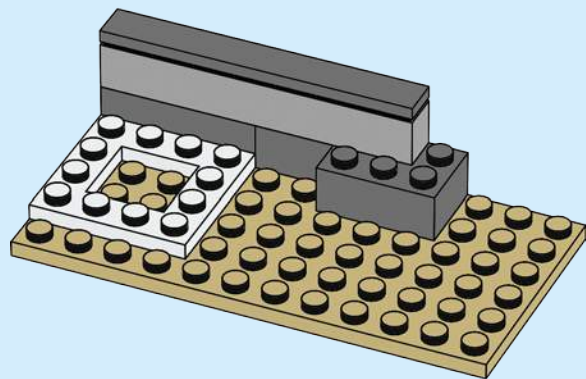

7

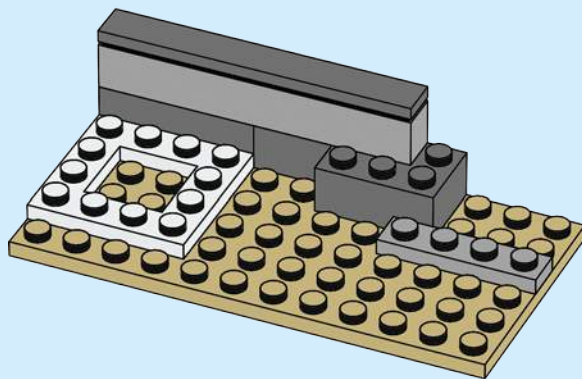



1x

8

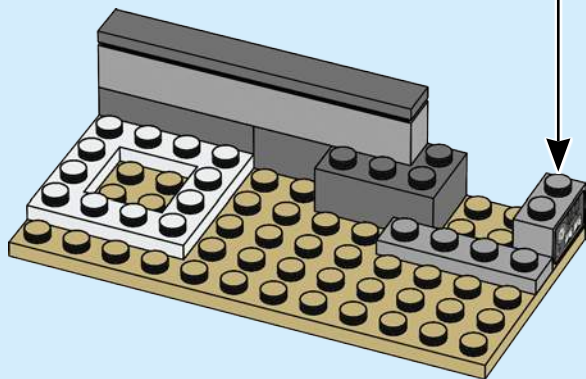
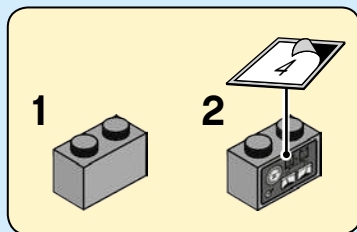



2x



1x

9

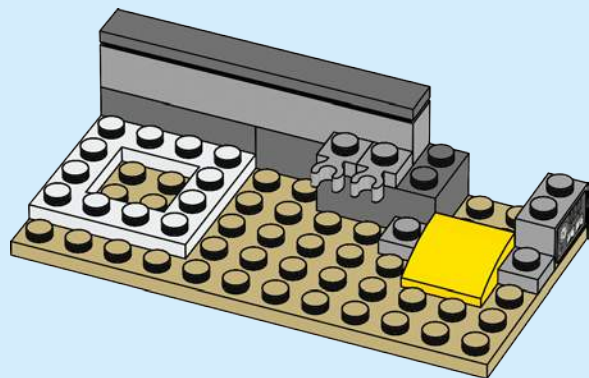

2x



1x

10

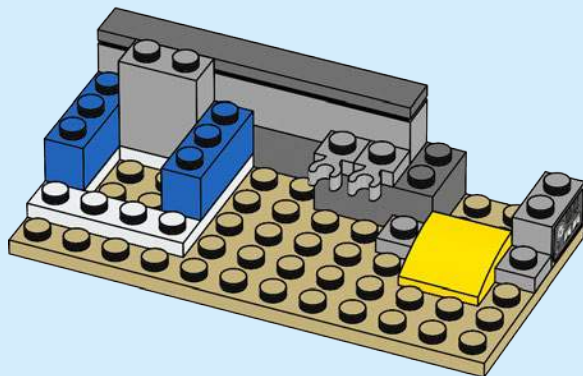



11

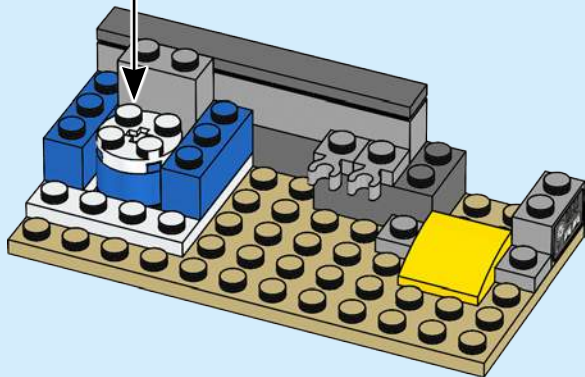
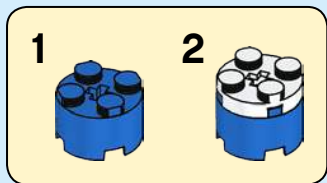

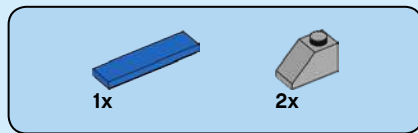

12

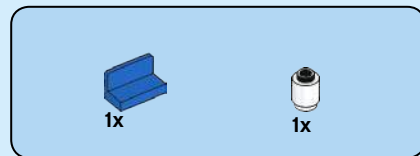
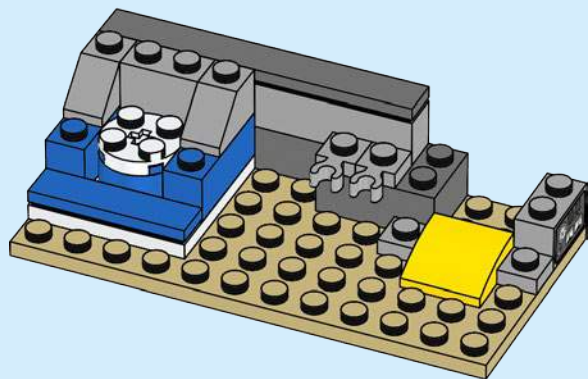

13

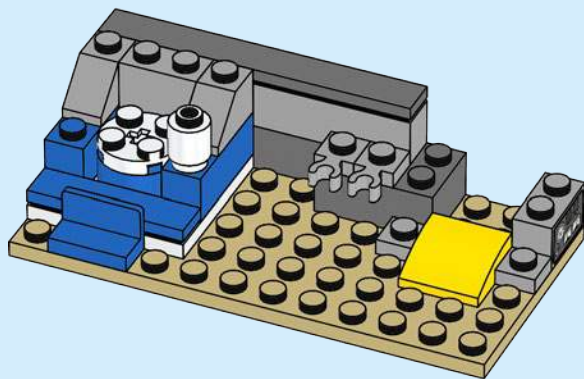

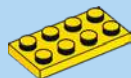
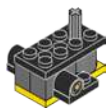

1x

14

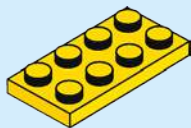

1x

15

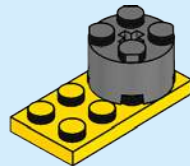



2x

16

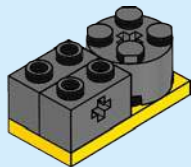

2x

17

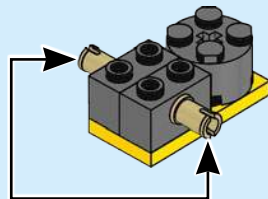

2x



18

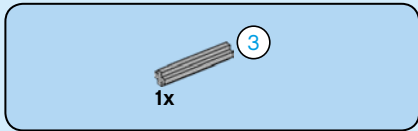
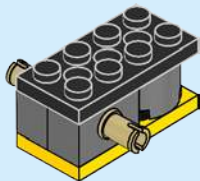

19

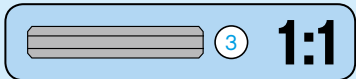
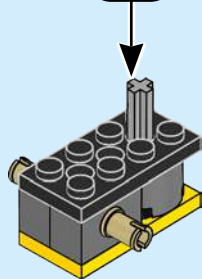
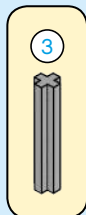



2x

20

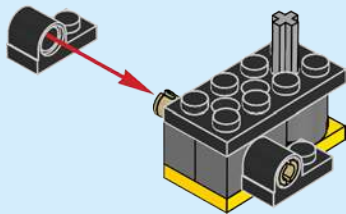

21

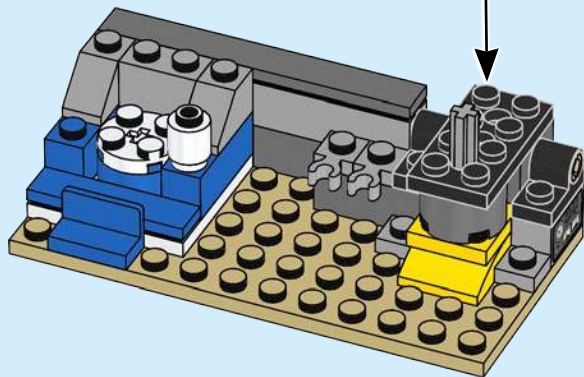



1x

22

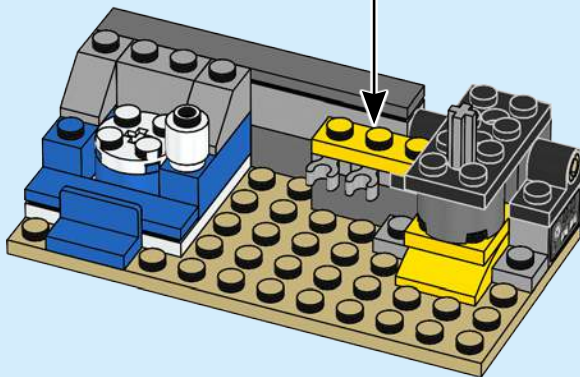
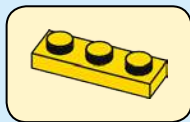



1x



1x



1x

23

1



2

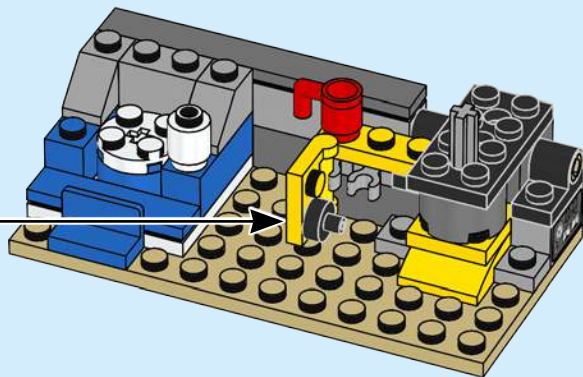

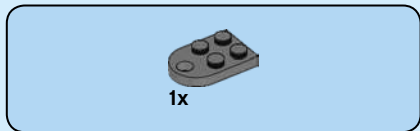
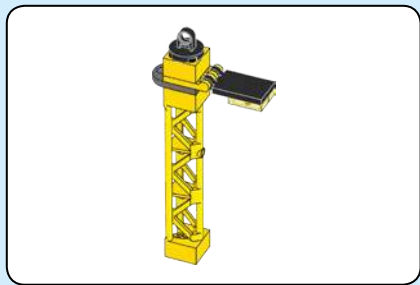

24

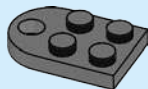



2x

25



1x

26





1x

27



2x



1x

28

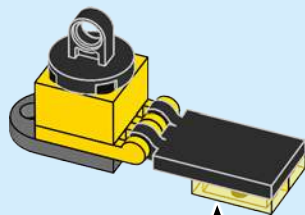

1



2

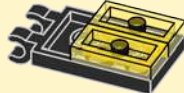

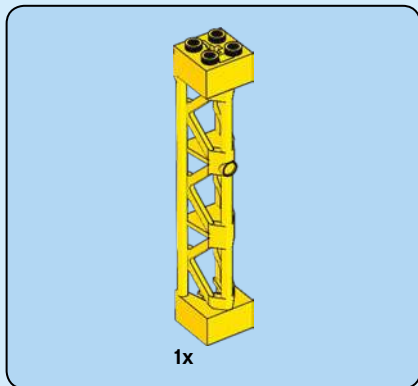

29

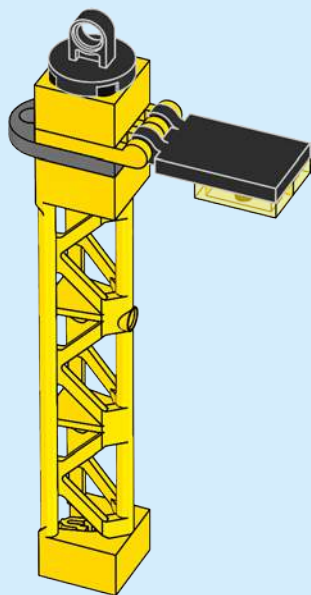

30

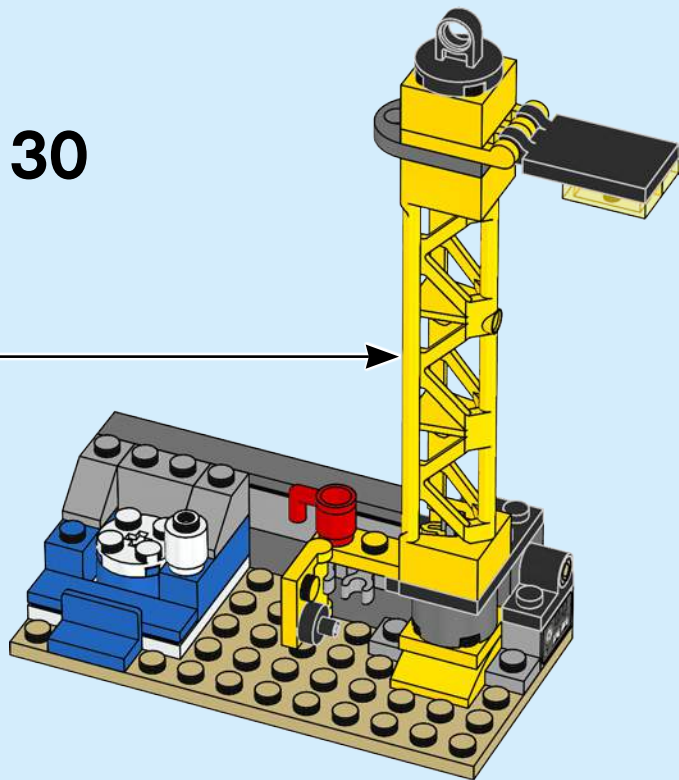

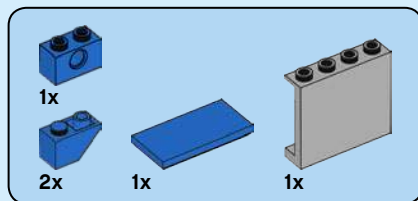

31

1

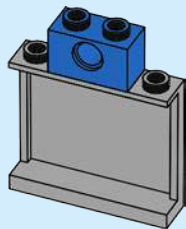

2

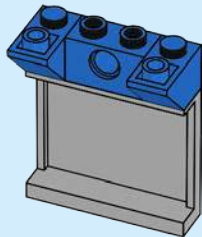

3

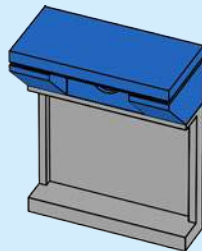

32

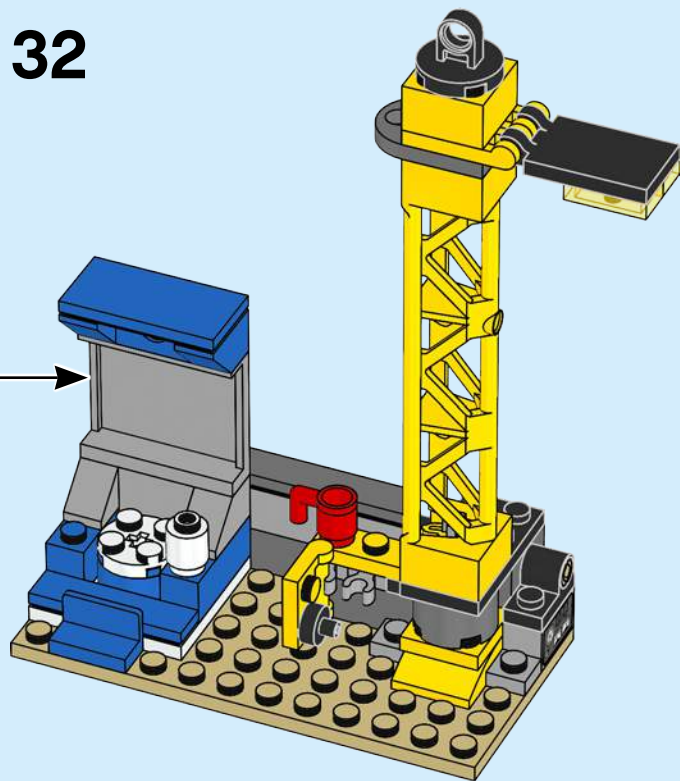

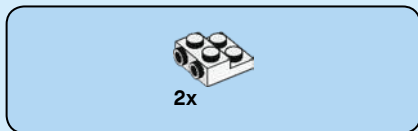
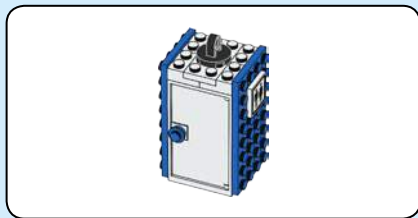

33

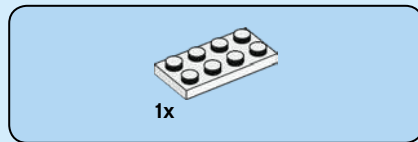
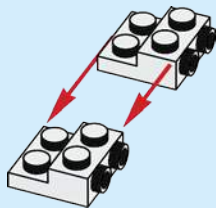

34

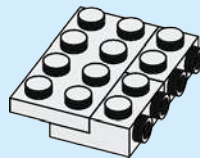



2x

35



2x

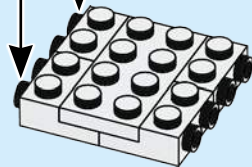

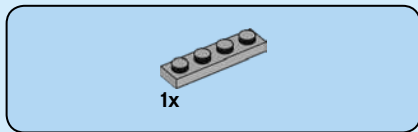

36

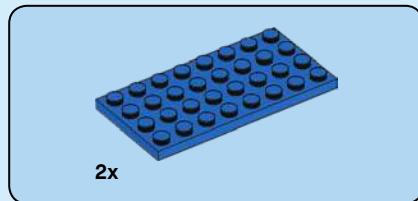
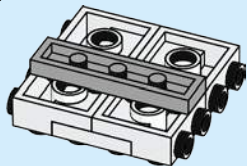
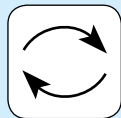

37

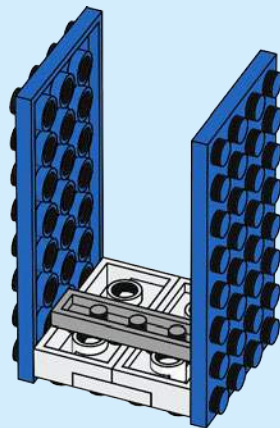

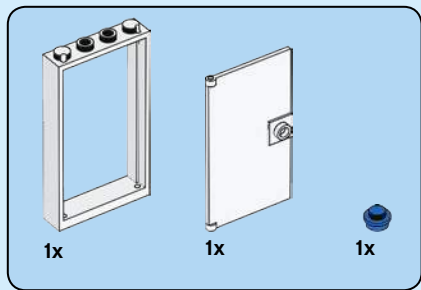

38

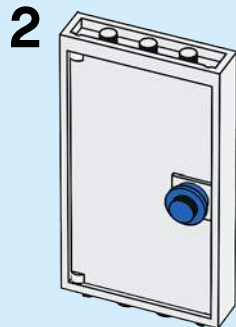
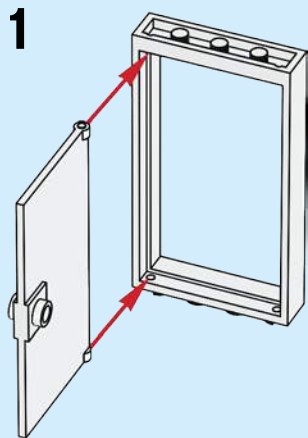



1x



1x

39

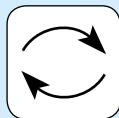

1



2

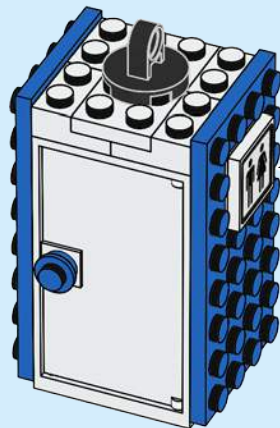
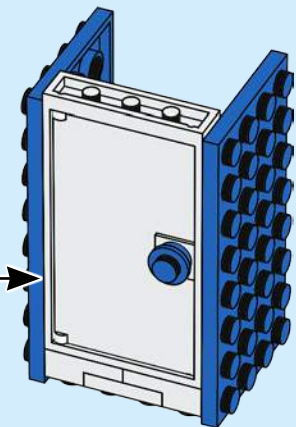

40

